

Dettaglio: Aggancio
Scala 3:1

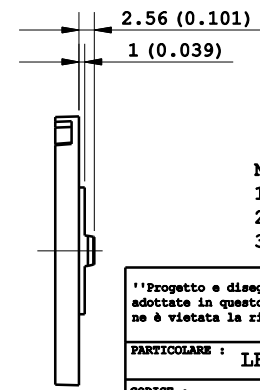
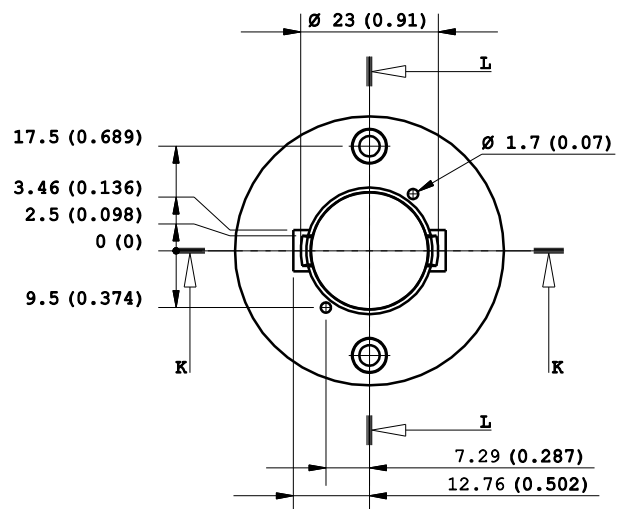
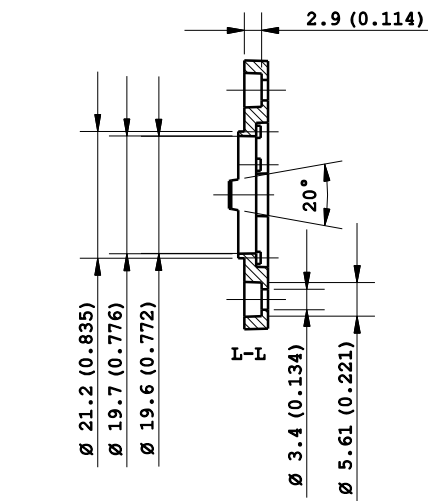
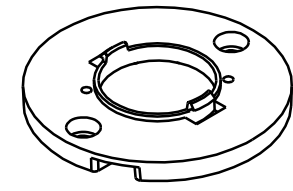
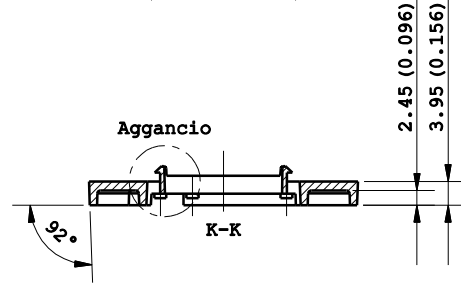

NOTE:
1- Dimensions in inches into brackets
2- For missing dimensions see the 3D file
3- Working temperature until 180°C

"Progetto e disegno di proprietà della KHATOD OPTOELECTRONIC s.r.l. Le soluzioni tecniche adottate in questo disegno sono di nostra esclusiva proprietà e quindi, a norma delle vigenti leggi, ne è vietata la riproduzione e la veicolazione a terzi senza nostra autorizzazione scritta."

PARTICOLARE : LED ADAPTOR BASE		DISEGNATORE : LM		PROGETTO : NAR_B19_S63_H35	
CODICE : ZOC 1598		VISTO : LM	CONTR: GV/SB	DATA : 25/02/2013	
KHATOD Via Monfalcone, 41 Cinisello Balsamo MILANO ITALIA WWW.KHATOD.COM		Tutte le dimensioni in mm. Toll. Gen. +/- 0.20 mm		TRATTAMENTI TERMICI : NO ONE	
		MATERIALE : APEC WHITE		SCALA : 1 : 1	
		FOGLIO : 1 of 1			