

Via Monfalcone 41
20092 Cinisello Balsamo (Milano) – Italy
Tel. +39 0266013695 – Fax +39 0266013500

CODE NUMBER: 11000000029

**SUBJECT: Secondary Optics for Power LEDs - PL600A06
Lens Coupling - Output Luminous Intensity Measurement**



- **Typ. Illuminance@1m ~ 7228lux**
- High lighting efficiency
- Excellent luminous flux
- No vibration problems
- NJC Technology
- Superior optical engineering for a perfect uniform light distribution
- Innovative design
- Easy fixing system to the PCB
- Complying with UL94 Specifications



Typical Application are:

- Wall Washing
- Architectural lighting
- Lamps
- Most applications where a compact light source is required
- Any application requiring placement of LEDs in narrow or recessed spaces, as well as in diverse LED configurations

Khatod Optics are a basic element to make your optical design real.

The right optical solution is fundamental for type and number of LEDs used in your design.

Advanced research, scientific rigour, great attention to the continuous evolution in LED Technology, have led Khatod to develop optical solutions performing an excellent, homogeneous luminous flux, and a high lighting efficiency.

The product we are proposing, is the result of Khatod's superior engineering. It helps in reducing the costs while meeting the most demanding lighting specifications and applications.

Contents:

Technical Data	- Page 1
Polar Intensity Plot	- Page 2
Luminous Intensity Graphics	- Page 3
Technical Drawing	- Page 4
Photographic reproduction of the Spot	- Page 5
Luminous Distribution Intensity Data	- Annex A
General Lens Features	- Annex B
General Notes	- Annex B

Via Monfalcone 41
200092 Cinisello Balsamo (Milano) - Italy
Tel. 0266013695 - Fax. +39 0266013500

CODE NUMBER: 11000000029

Goniophotometer Type	KLX12M	Operator	SIMONE BASSI
Power Supply Type	ISO TECH ISP3303	Date	07/02/2011
LED Driver Type	////		

Lamp Model	////	Nominal Flux (lm)	130	Angle FWHM C Plane	14
Lens Model	PL600A06	Total Flux (lm)	390	Angle FWHM γ Plane	12
LED Model	REBEL ES	Imax (cd)	3012		
N. LED	3	Max Ill. @ Meas. Dist. (lux)	120	Total Incl. Angle C Plane	26
Rated Voltage (V)	8.9	Measurement Distance (m)	5	Total Incl. Angle γ Plane	28
LED Drive Current (mA)	350	Room Temperature (°C)	25		

Notes:
General Optical Measurement Tolerance: +/-10%

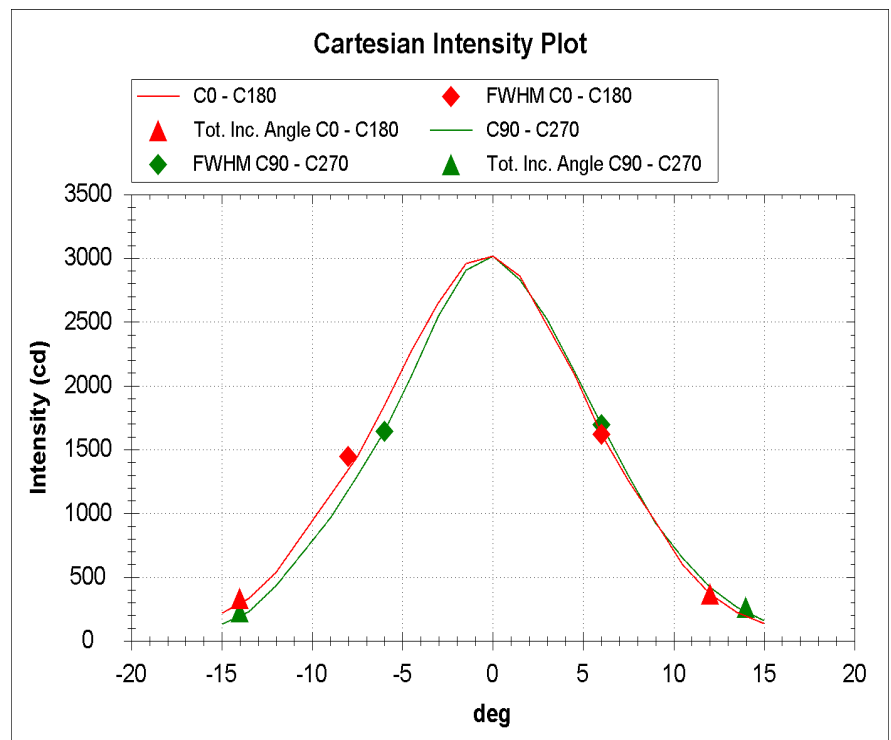
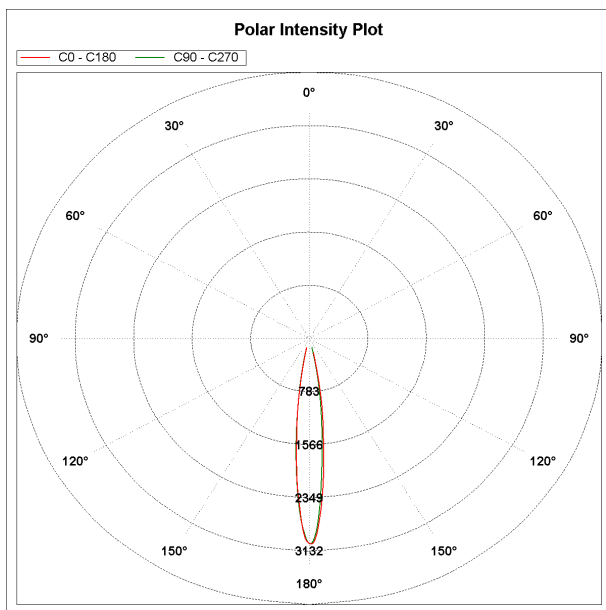

Polar Intensity Plot

— C0 - C180 — C90 - C270

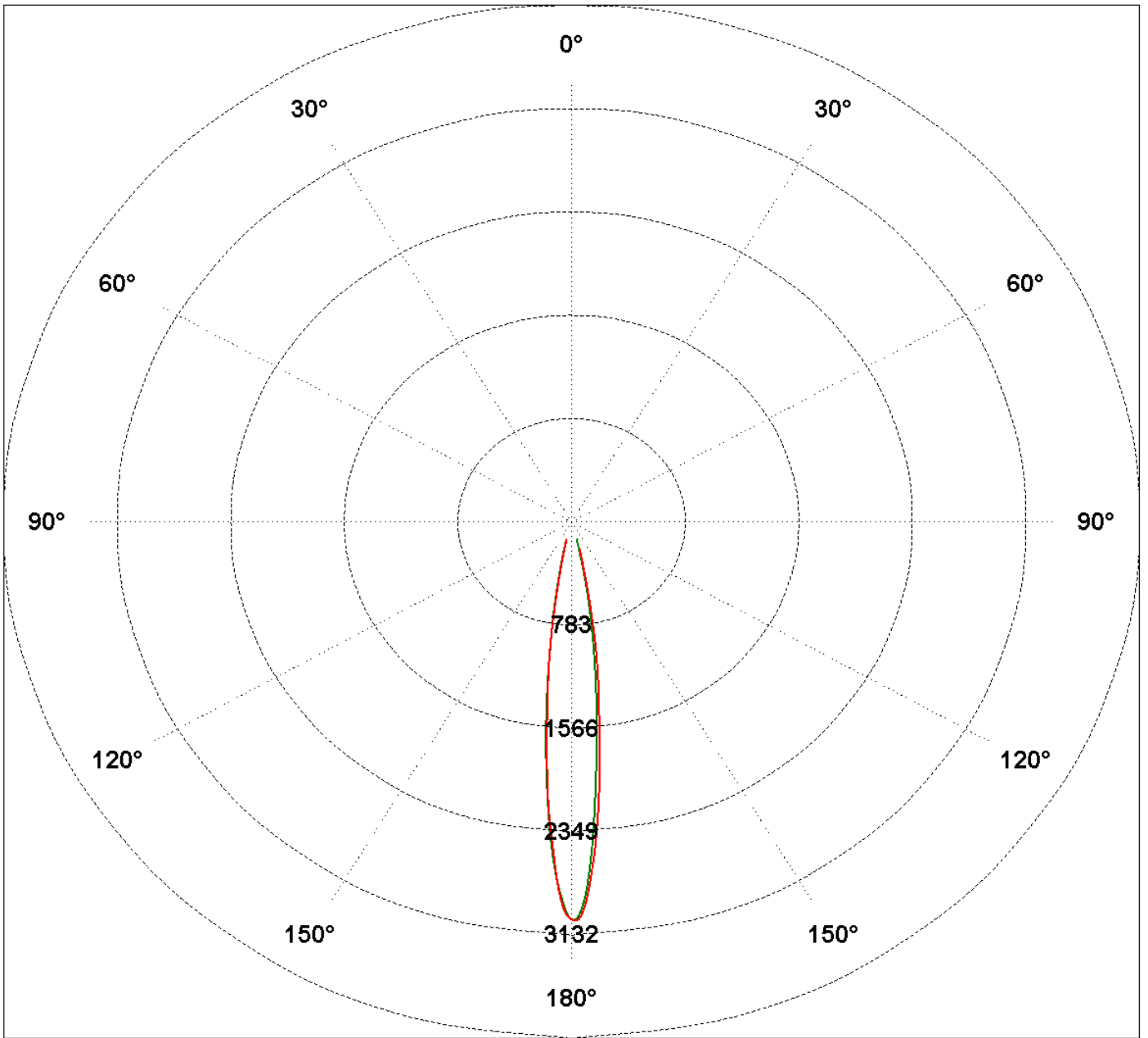

Figure C0-C180

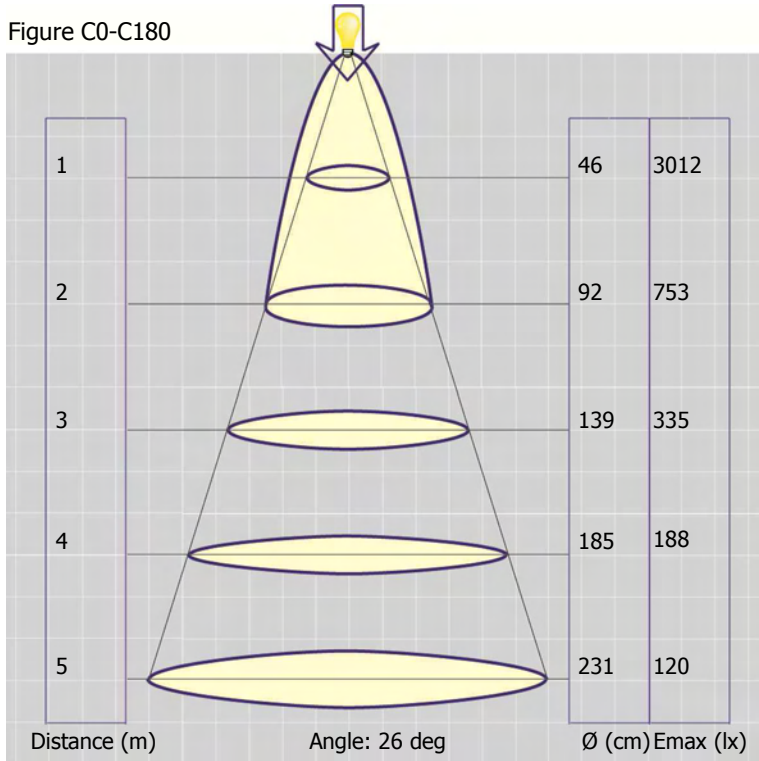
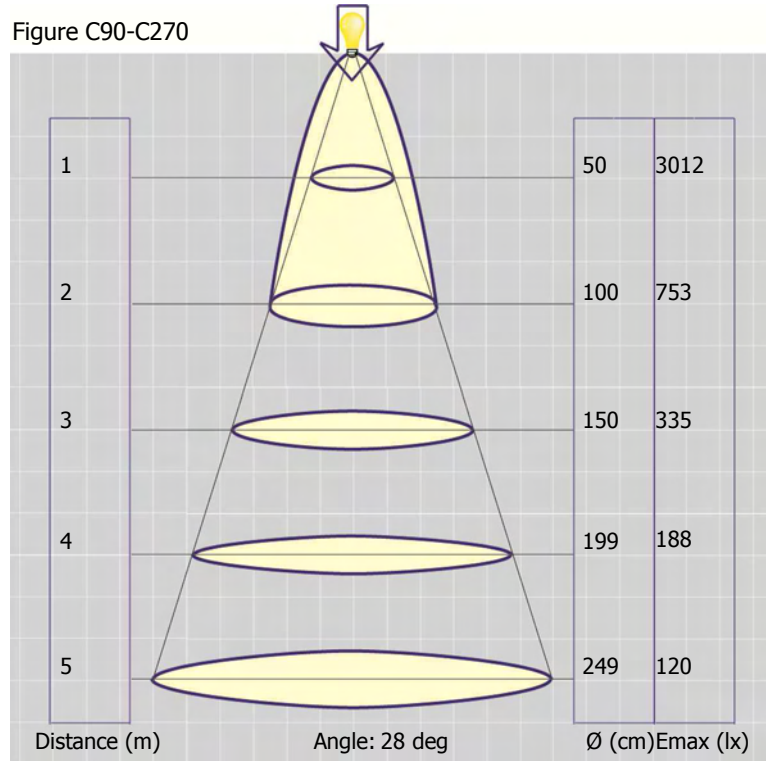
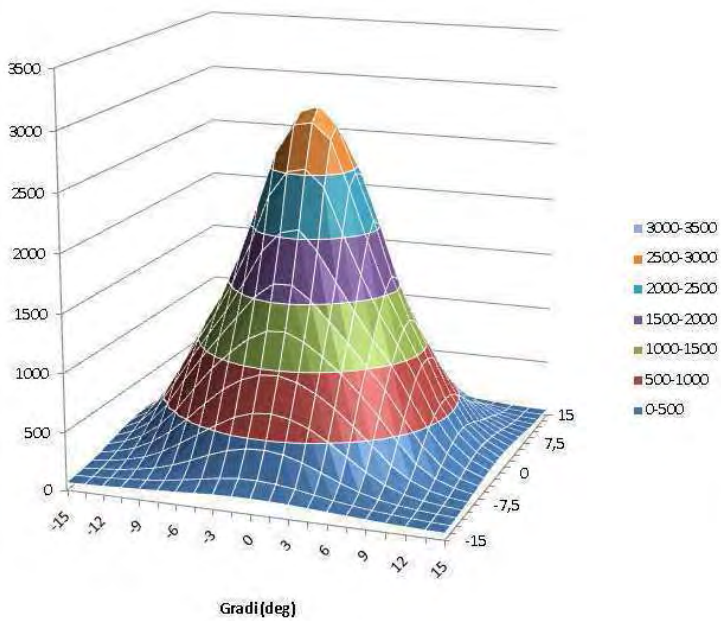

Figure C90-C270



Isocandela Diagram



Isolux Diagram

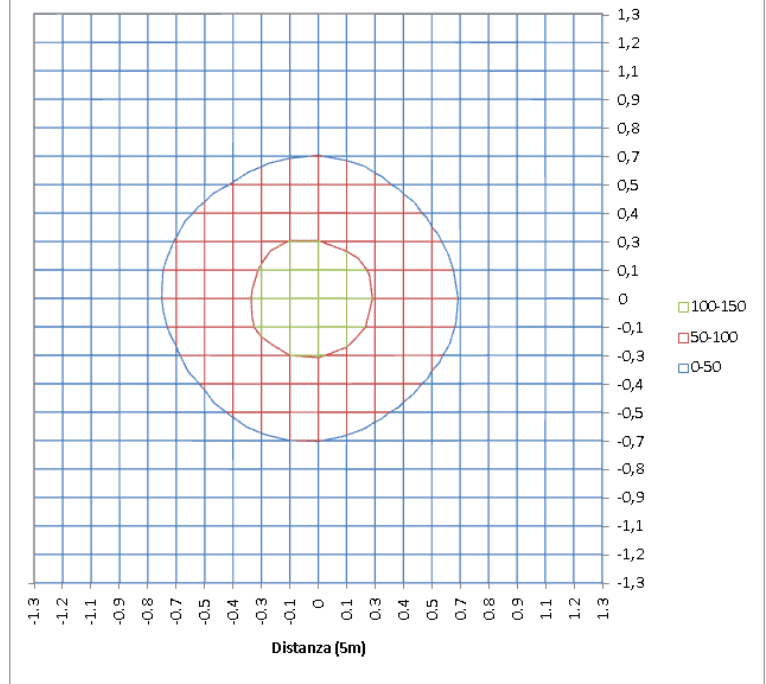

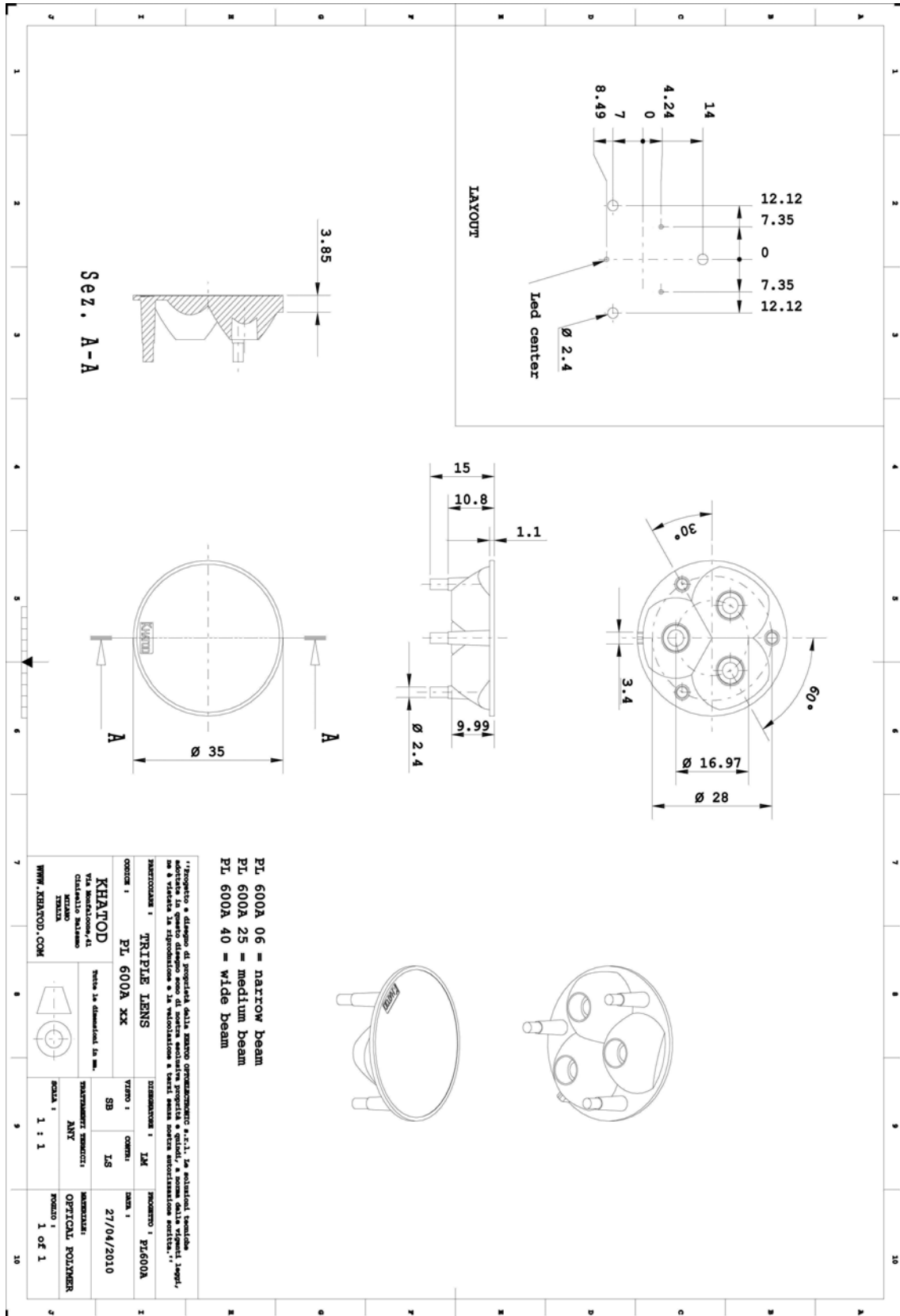

Gray Scale Illuminance @ 5m Distance

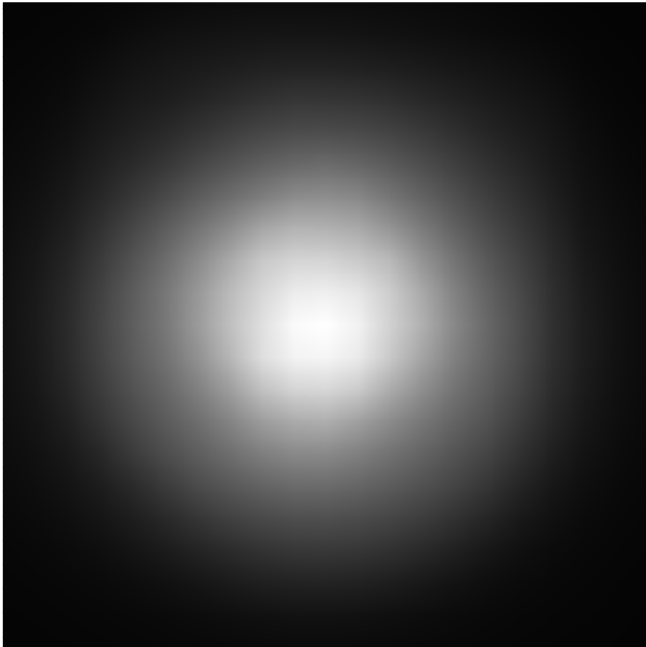

False Colours Illuminance @ 5m Distance

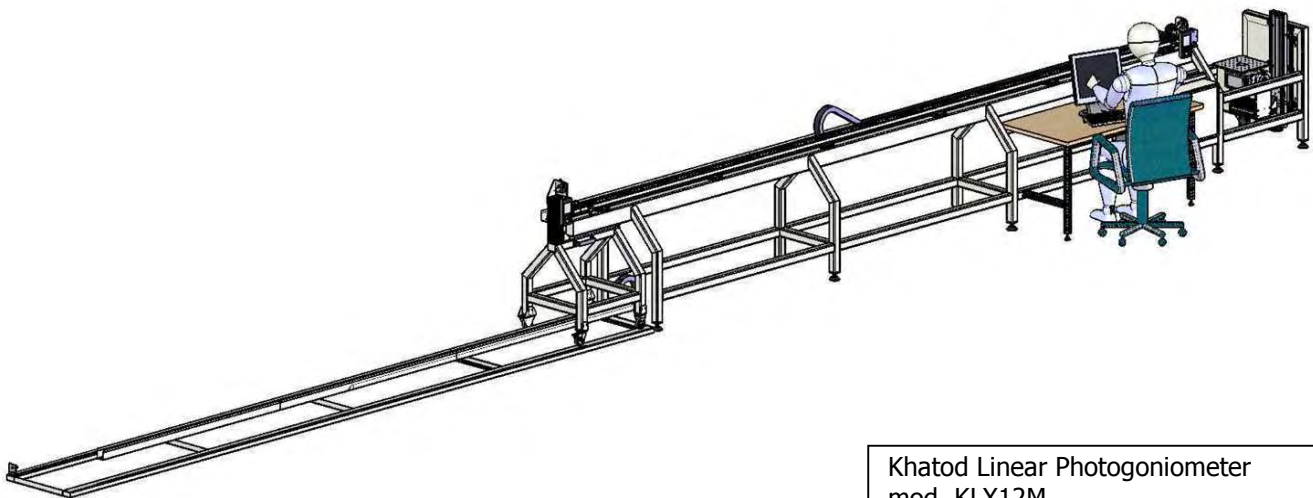
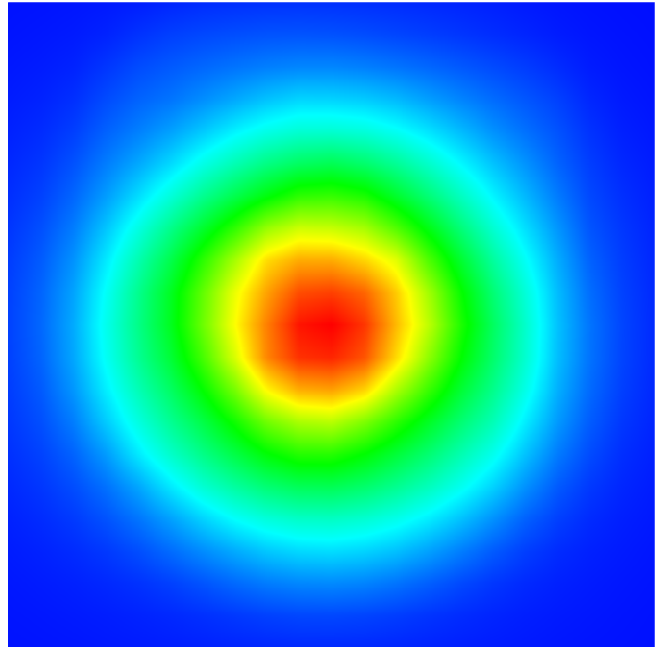

Khatod Linear Photogoniometer
mod. KLX12M

Luminous Distribution Intensity Data

CODE NUMBER: 110000000029

C (deg) γ (deg)	0°	10°	20°	30°	40°	50°	60°	70°	80°	90°	100°	110°	120°	130°	140°	150°	160°	170°	180°	190°
0°	3012	3012	3012	3012	3012	3012	3012	3012	3012	3012	3012	3012	3012	3012	3012	3012	3012	3012	3012	3012
5°	1930	1911	1917	1896	1909	1911	1902	1934	1943	1970	1997	2050	2077	2114	2132	2132	2146	2129	2131	2092
10°	712	709	707	700	696	704	714	723	734	743	762	760	765	778	809	862	903	930	940	927
15°	135	138	145	152	179	199	179	163	156	157	176	206	235	239	217	205	209	216	215	215
20°	0	0	0	0	0	0	0	0	0	0	0	0	0	0	0	0	0	0	0	0
25°	0	0	0	0	0	0	0	0	0	0	0	0	0	0	0	0	0	0	0	0
30°	0	0	0	0	0	0	0	0	0	0	0	0	0	0	0	0	0	0	0	0
35°	0	0	0	0	0	0	0	0	0	0	0	0	0	0	0	0	0	0	0	0
40°	0	0	0	0	0	0	0	0	0	0	0	0	0	0	0	0	0	0	0	0
45°	0	0	0	0	0	0	0	0	0	0	0	0	0	0	0	0	0	0	0	0
50°	0	0	0	0	0	0	0	0	0	0	0	0	0	0	0	0	0	0	0	0
55°	0	0	0	0	0	0	0	0	0	0	0	0	0	0	0	0	0	0	0	0
60°	0	0	0	0	0	0	0	0	0	0	0	0	0	0	0	0	0	0	0	0
65°	0	0	0	0	0	0	0	0	0	0	0	0	0	0	0	0	0	0	0	0
70°	0	0	0	0	0	0	0	0	0	0	0	0	0	0	0	0	0	0	0	0
75°	0	0	0	0	0	0	0	0	0	0	0	0	0	0	0	0	0	0	0	0
80°	0	0	0	0	0	0	0	0	0	0	0	0	0	0	0	0	0	0	0	0
85°	0	0	0	0	0	0	0	0	0	0	0	0	0	0	0	0	0	0	0	0
90°	0	0	0	0	0	0	0	0	0	0	0	0	0	0	0	0	0	0	0	0

200°	210°	220°	230°	240°	250°	260°	270°	280°	290°	300°	310°	320°	330°	340°	350°
3012	3012	3012	3012	3012	3012	3012	3012	3012	3012	3012	3012	3012	3012	3012	3012
2073	2027	2016	2010	1974	1960	1936	1931	1863	1821	1789	1788	1804	1824	1861	1883
900	877	856	834	810	797	789	781	764	753	748	756	761	750	742	726
212	202	190	173	156	147	138	129	135	137	138	140	143	144	145	141
0	0	0	0	0	0	0	0	0	0	0	0	0	0	0	0
0	0	0	0	0	0	0	0	0	0	0	0	0	0	0	0
0	0	0	0	0	0	0	0	0	0	0	0	0	0	0	0
0	0	0	0	0	0	0	0	0	0	0	0	0	0	0	0
0	0	0	0	0	0	0	0	0	0	0	0	0	0	0	0
0	0	0	0	0	0	0	0	0	0	0	0	0	0	0	0
0	0	0	0	0	0	0	0	0	0	0	0	0	0	0	0
0	0	0	0	0	0	0	0	0	0	0	0	0	0	0	0
0	0	0	0	0	0	0	0	0	0	0	0	0	0	0	0
0	0	0	0	0	0	0	0	0	0	0	0	0	0	0	0
0	0	0	0	0	0	0	0	0	0	0	0	0	0	0	0
0	0	0	0	0	0	0	0	0	0	0	0	0	0	0	0
0	0	0	0	0	0	0	0	0	0	0	0	0	0	0	0
0	0	0	0	0	0	0	0	0	0	0	0	0	0	0	0
0	0	0	0	0	0	0	0	0	0	0	0	0	0	0	0
0	0	0	0	0	0	0	0	0	0	0	0	0	0	0	0

Lens characteristics

Parameter	Symbol	Rating	Unit
Lens Material	PMMA Optics	--	--
Holder Material	--	--	--
Operating Temperature	Topr	-30 to +80	°C
Storage Temperature	Tstg	-30 to +80	°C

Notes:

Please note that flow lines and weld lines on the external surfaces of the lenses are acceptable if the optical performance of the lens is within the specification described in the section "OPTICAL CHARACTERISTICS"

- Should you require further information, please contact Khatod for advice.
- All lens testing must be subject to identical conditions as Khatod test condition.
- Published by Khatod optoelectronic srl - All the data contained in this document are the property of Khatod optoelectronic srl and may change without notice.

KHATOD LENS Use And Maintenance

- DO NOT HANDLE OR INSTALL LENSES WITHOUT WEARING GLOVES, SKIN OILS MAY DAMAGE LENS OR LIGHT TRANSMISSION
- CLEAN LENSES WITH MILD SOAP AND WATER AND A SOFT CLOTH
- DO NOT USE ANY COMMERCIAL CLEANING SOLVENTS ON LENSES

Khatod SRL, Milan, Italy, manufactures lenses for LEDs. Any other use of the lens shall void our liability and warranty. The lenses are an inert component to be used in the manufacture of various products. Our warranty and liability are limited only to the manufacture of the lens. You may not modify, copy, distribute reproduce, license or alter the lens and related materials of Khatod SRL. Khatod SRL does not warrant against damages or defects arising out of the use or misuse of the products; against defects or damage arising from improper installation, or against defects in the product or in its components. No warranty of any kind, expressed or implied, is made regarding the safety of the products. The entire risk as to the quality or performance of the product is with the buyer. In no event shall Khatod SRL be liable for any direct, indirect, punitive, incidental, special, consequential damages, or any damages whatsoever arising out of or connected with the use or misuse of the product. Khatod SRL shall not have any obligation with respect to the product or any part thereof, whether based on contract, tort, strict liability or otherwise. Buyer assumes all risks and liability from use of the product. The laws of Milan, Italy govern this product warranty and liability and you hereby consent to the exclusive jurisdiction and venue of courts in Milan, Italy in all disputes arising out of or relating to the use of this product.

