

KNAC0444ASM - 90° FWHM

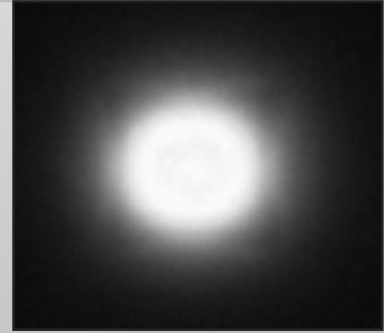

Engineered for 3535 LEDs and
Compatible with 5050 LEDs

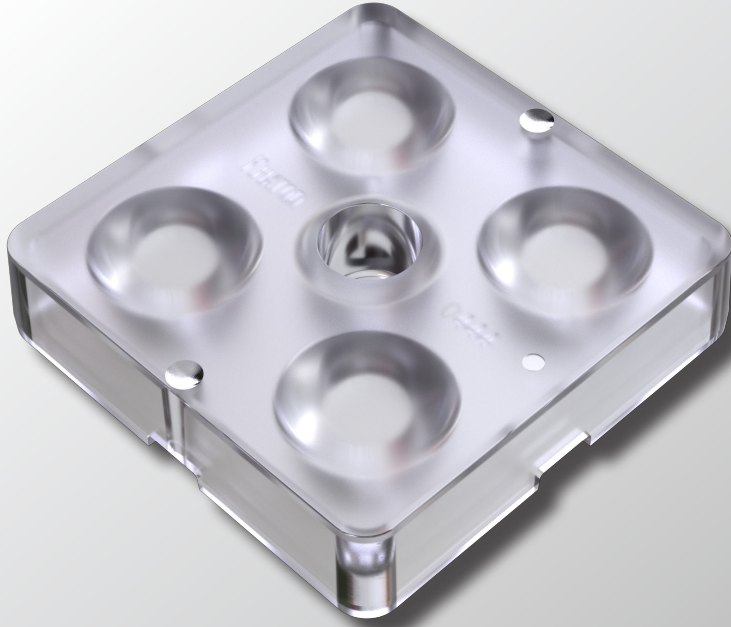
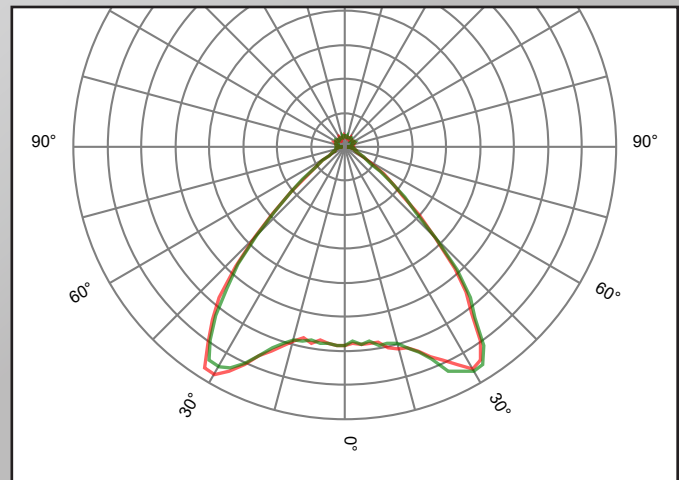

Dimensions	Type of fixing	Material	Beams	LED
50.00mm x 50.00mm side - 11.00mm height - Lens pitch: 25.40 mm	Screw Fixing: [~ 0.6/1.0 Nm] for M4 screws	PMMA Clear	<ul style="list-style-type: none"> Full angle at 50% from maximum: ~ 90° Full angle at 10% from maximum: ~ 125° 	~330lm@700mA

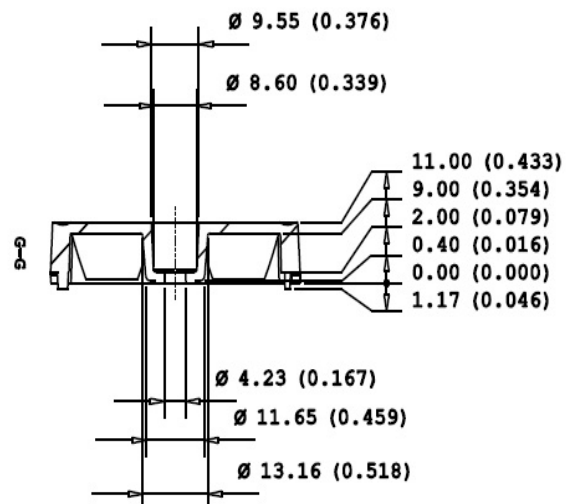
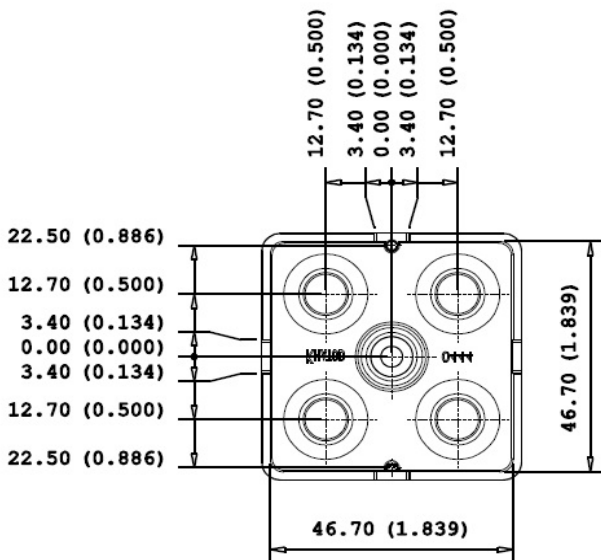

Assembly Specifications

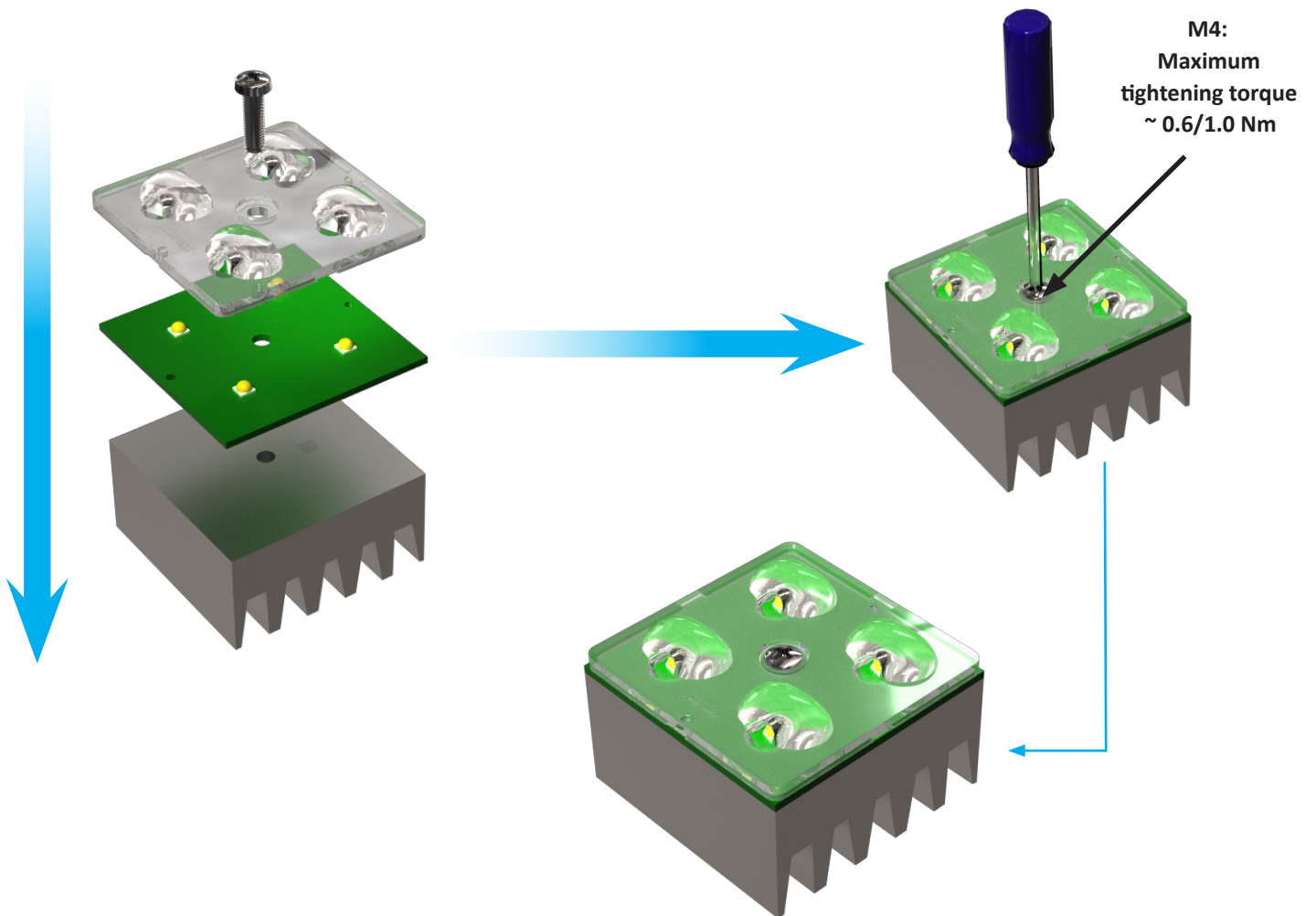
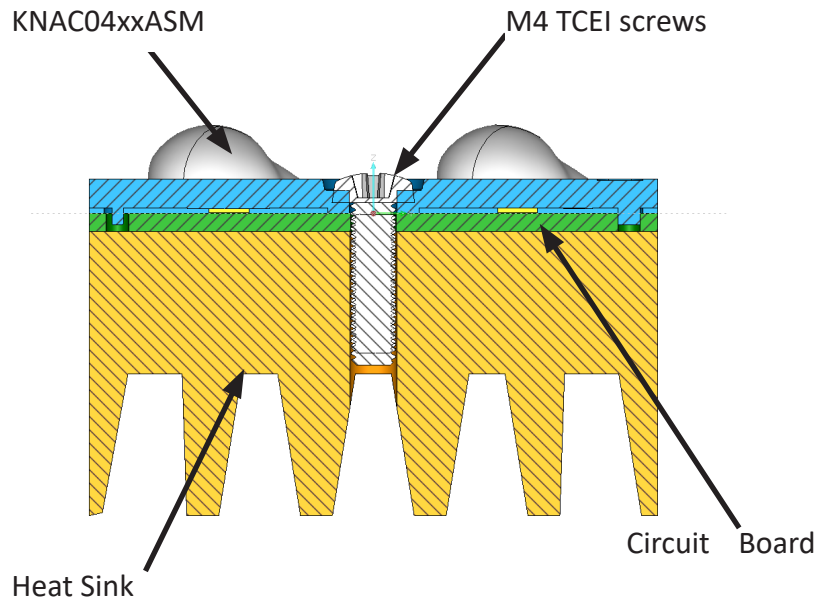

PCB for Test - KFP38

Khatod supplies KFP38 PCBs to facilitate customers' tests.
Circuit diagrams and photos are shown below.



KFP38

1832 lumen @ 1050 mA

- CCT: 4000K
- Nominal Flux: 1832 lm @ 25°C tc
- Power: 19.8W @ 1050mA

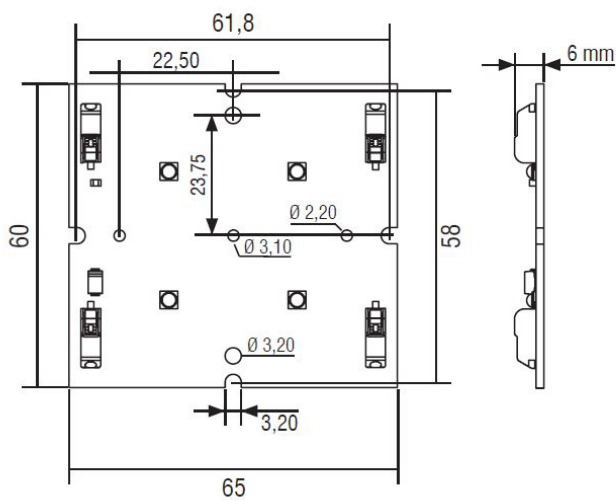

Dimensions in mm

Wiring

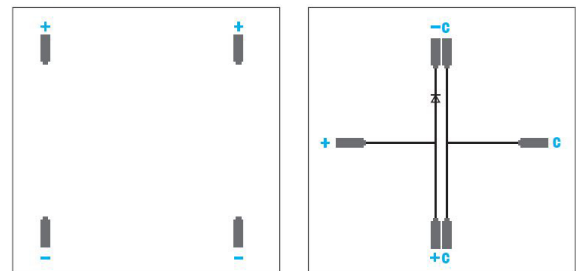

0,34 - 0,75 mm²

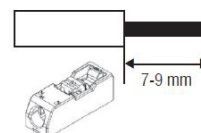

Insert/remove wires by slightly pressing on push-button.

Packaging

Item	Quantity	Total Parts	Size (L*W*H)	G.W.
Cardboard	45 pcs per Cardboard	45 pcs	50*32 cm	0.52 Kg
Outer Box	25 Cardboards per Outer Box	1125 pcs	50*32*38 cm	16 Kg



25 Cardboards / 45 Modules each



25 Cardboards / Outer Box

Materials

Material	Temperatures
PMMA 8N **	-40° / + 90°C
PC	-40° / + 120°C

For further information please visit Evonik website

**

KNAC04xxxSM is made of the same material used to produce PLEXIGLAS® Solar which guarantees it will show no yellowing for 10 years. Yellowness Index (YI) according to the test standards for Arizona/Florida outdoor exposure testing:

- YI 6 under hot/dry conditions
- YI 8 under hot/wet conditions

Tests

The present document is an internal document showing the tests carried out by Khatod in its laboratory. The tests, photos and videos presented in this document are made available for demonstration purposes only. Khatod, with its laboratory, is not a certification body.

Test	Link
Climatic Test 	Click here

Notes:

- Intensity (I) and illuminance (E) data are normalized by 1000 lm
- The optical values shown are the result of optical simulations carried out with LIGHTTOOLS, ASAP and ZEMAX software systems. The optical simulations are carried out on the basis of the typical values provided in the LED manufacturers' official datasheets. The photometric analysis has been carried out on physical samples. On request, by supplying your PCB, we can provide the measurement photometric file.

Use and Maintenance

1. DO NOT HANDLE OR INSTALL LENSES WITHOUT WEARING GLOVES, SKIN OILS MAY DAMAGE LENS OR LIGHT TRANSMISSION;
2. CLEAN LENSES WITH MILD SOAP AND WATER AND A SOFT CLOTH;
3. DO NOT USE ANY COMMERCIAL CLEANING SOLVENTS ON LENSES.

Disclaimer

Please note that flow lines and weld lines on the external surfaces of the lenses are acceptable if the optical performance of the lens is within the specifications.

Should you require further information, please contact Khatod for advice. All lens testing must be subject to identical conditions as Khatod test condition. Khatod Optoelectronic, Milan, Italy, manufactures lenses for LEDs. Any other use of the lens shall void our liability and warranty. The lenses are an inert component to be used in the manufacture of

various products. Our warranty and liability are limited only to the manufacture of the lens. You may not modify, copy, distribute reproduce, license or alter the lens and related materials of Khatod. Khatod does not warrant against damages or defects arising out of the use or misuse of the products; against defects or damage arising from improper installation, or against defects in the product or in its components. No warranty of any kind, expressed or implied, is made regarding the safety of the products. The entire risk as to the quality or performance of the product is with the buyer. In no event

shall Khatod be liable for any direct, indirect, punitive, incidental, special, consequential damages, or any damages whatsoever arising out of or connected with the use or misuse of the product. Khatod shall not have any obligation with respect to the product or any part thereof, whether based on contract, tort, strict liability or otherwise. Buyer assumes all risks and liability from use of the product. The laws of Milan, Italy govern this product warranty and liability and you hereby consent to the exclusive jurisdiction and venue of courts in Milan, Italy in all disputes arising out of or relating to the use of this product. Production, marketing, distribution, sale of these products as well as their possible modifications and variations are only exclusive right of Khatod Optoelectronic. No company can perform any of these actions without written permission released by Khatod Optoelectronic. The information contained in this document is proprietary of Khatod Optoelectronic and may change without notice.

REPRODUCTION PROHIBITED.