

Via Monfalcone 41
20092 Cinisello Balsamo (Milano) – Italy
Tel. +39 0266013695 – Fax +39 0266013500

KHS502 Heat Sink for Power LEDs 1W - 3W



KHS Series

- High efficiency
- 45mm Diameter
- Most applications where a compact light source is required

Technical data

- R_{th} (°C/W) = 11,0 °C/W
- W/mK = 193 - 200 (Therm cond.)
- Material: Aluminium ALMgSi0,5
UNI 6060 DIN 1725
- Kg/dm^3 = 2,70 (Spec. gravity)

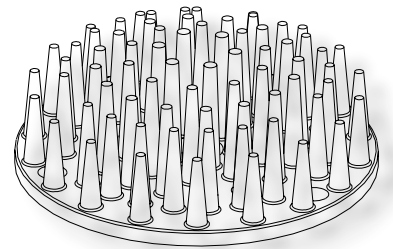

DESCRIPTION:

The KHS502 series has been designed for 1 - 3W POWER LEDs. The Heat Sink performance is measured basing on its Thermal Resistance (R_{th}), where R_{th} is the temperature increase (ΔT) in Centigrade degrees caused by application of 1 Watt power. As Being national or international test methods to evaluate R_{th} not available, the values to considered are the ones coming from laboratory tests.

Drawing

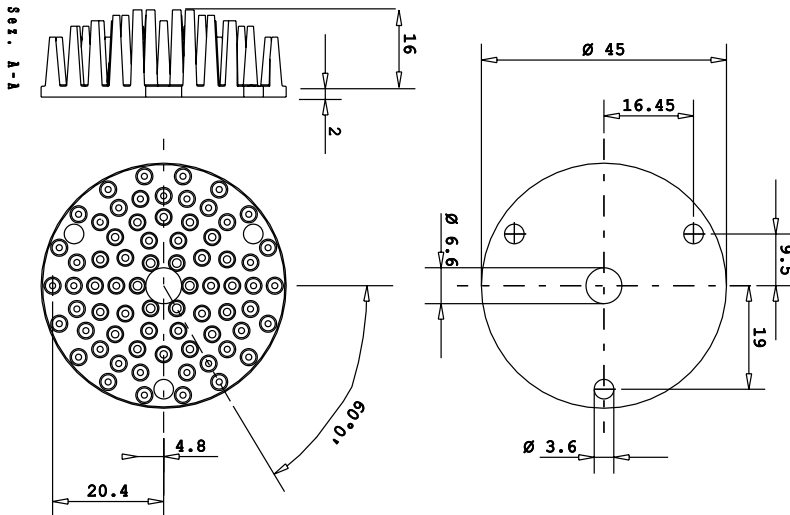

Diagram

HeatSink Performance

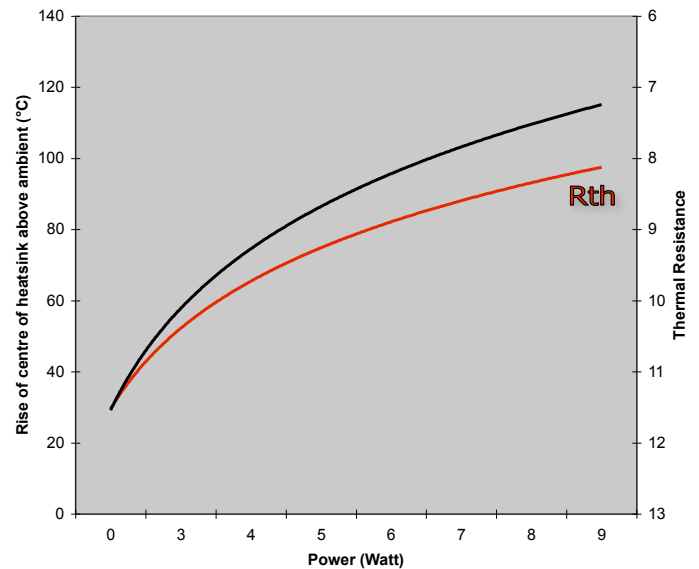

The Terminal resistance is calculated considering a uniform heat source on heat sink. The above measures are given only as a reference and may change (UNI 3879 - DIN 1748). All thermal resistance values (R) are indicative and refer only to the heat sink surface.