

Via Monfalcone 41  
20092 Cinisello Balsamo (Milano) – Italy  
Tel. +39 0266013695 – Fax +39 0266013500

**CODE NUMBER: 120000000252**

**SUBJECT: KEPL140060 Lens Coupling - Output Luminous Intensity Measurement**

---



- High lighting efficiency
- Excellent luminous flux
- Superior optical engineering for a perfect uniform light distribution
- Easy fixing system to the PCB
- No vibration problems
- Complying with UL94 Specifications
- UV protected

### **Typical Applications:**

Khatod Optics are suitable for any application in Wide Area Lighting, Indoor and Outdoor:

- Wall Washing
- Architectural lighting
- Lamps
- Bike Lights
- Most applications where a compact light source is required
- Any applications in narrow or recessed spaces

Khatod Optics are a basic element to make your optical design real.

The right optical solution is fundamental for type and number of LEDs used in your design.

Advanced research, scientific rigour, great attention to the continuous evolution in LED Technology, have led Khatod to develop optical solutions performing an excellent homogeneous luminous flux, and high lighting efficiency.

Khatod delivers the widest range of Single, Triple, Quad and Multiple Lenses, compliant with MR16, MR11, AR111 Standards, for the major LEDs manufacturers

They are available in a variety of beam angles: Narrow, Medium, Wide, Super-Wide, Elliptical and special Blade-Shaped Beam.

Khatod Lenses meet the most demanding lighting specifications and applications, while delivering real cost-effective and competitive products.

## **Contents**

|          |                                  |          |
|----------|----------------------------------|----------|
| <b>1</b> | <b>Light Source Model</b>        | <b>3</b> |
| <b>2</b> | <b>Measurement Setup</b>         | <b>3</b> |
| <b>3</b> | <b>Results</b>                   | <b>3</b> |
| <b>4</b> | <b>Intensity Plot</b>            | <b>4</b> |
| <b>5</b> | <b>Illuminance Map</b>           | <b>5</b> |
| <b>6</b> | <b>Isolux / Isocandela Plots</b> | <b>6</b> |
| <b>7</b> | <b>Illuminance Diagram</b>       | <b>7</b> |
| <b>8</b> | <b>Drawing</b>                   | <b>8</b> |
| <b>9</b> | <b>Use and Maintenance</b>       | <b>9</b> |

## 1 Light Source Model

| Parameter                      | Symbol | Value            | Unit |
|--------------------------------|--------|------------------|------|
| Lens / Reflector Model         | -      | KEPL140060       | -    |
| Material (More info on page 9) | -      | PC, PMMA         | -    |
| Dimensions                     | -      | See page 8       | -    |
| Source Model                   | -      | LUXEON A         | -    |
| Number of Sources              | $N$    | 3                | -    |
| Power Supply Type              | -      | ISO TECH ISP3303 | -    |
| Driver Type                    | -      | -                | -    |
| Driving Voltage                | $V_F$  | -                | V    |
| Driving Current                | $I_F$  | 700              | mA   |
| Nominal Flux                   | $\Phi$ | 150×3            | lm   |

## 2 Measurement Setup

| Parameter            | Symbol | Value        | Unit |
|----------------------|--------|--------------|------|
| Operator             | -      | Simone Bassi | -    |
| Goniophotometer Type | -      | KLX12M       | -    |
| Measurement Distance | $z$    | 5            | m    |
| Room Temperature     | $T$    | 25           | °C   |
| Date                 | -      | 28-Mar-2012  | -    |

## 3 Results

| Parameter                                 | Symbol               | Value | Unit |
|---|----------------------|-------|------|
| Total Flux                                | $\Phi$               | 450   | lm   |
| Max Intensity                             | $I_{\max}$           | 608   | cd   |
| Max Illuminance at 5 m                    | $E_{\max}$           | 24    | lx   |
| C-Viewing Angle at 50% $I_{\max}$         | $2\phi_C$            | 47    | °    |
| $\gamma$ -Viewing Angle at 50% $I_{\max}$ | $2\phi_\gamma$       | 48    | °    |
| C-Viewing Angle at 10% $I_{\max}$         | $2\phi_{C10\%}$      | 69    | °    |
| $\gamma$ -Viewing Angle at 10% $I_{\max}$ | $2\phi_{\gamma10\%}$ | 70    | °    |
| General Optical Measurement Tolerance     | -                    | ±10%  | -    |

### NOTES:

- Intensity ( $I$ ) and illuminance ( $E$ ) data are normalized by 1000 lm
- The optical values shown are the result of optical simulations carried out with ASAP and ZEMAX software systems. The optical simulations are carried out on the basis of the typical values provided in the LED manufacturers' official datasheets. The photometric analysis has been carried out on physical samples. On request, by supplying your PCB, we can provide the measurement photometric file.

## 4 Intensity Plot

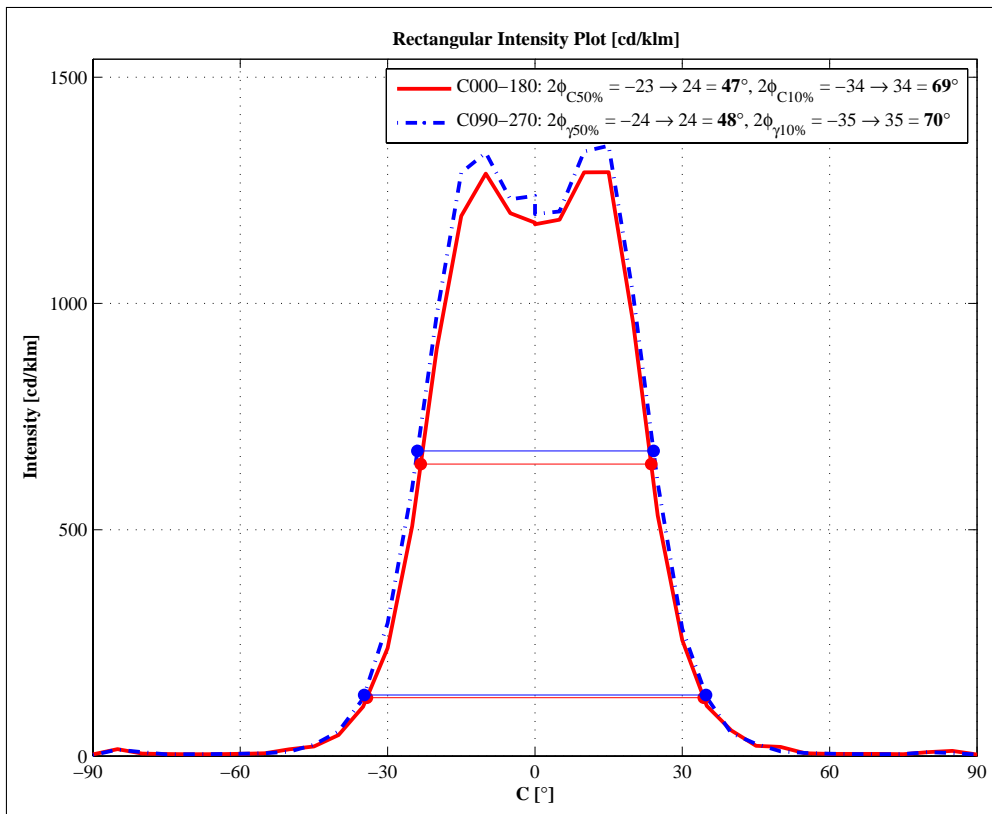
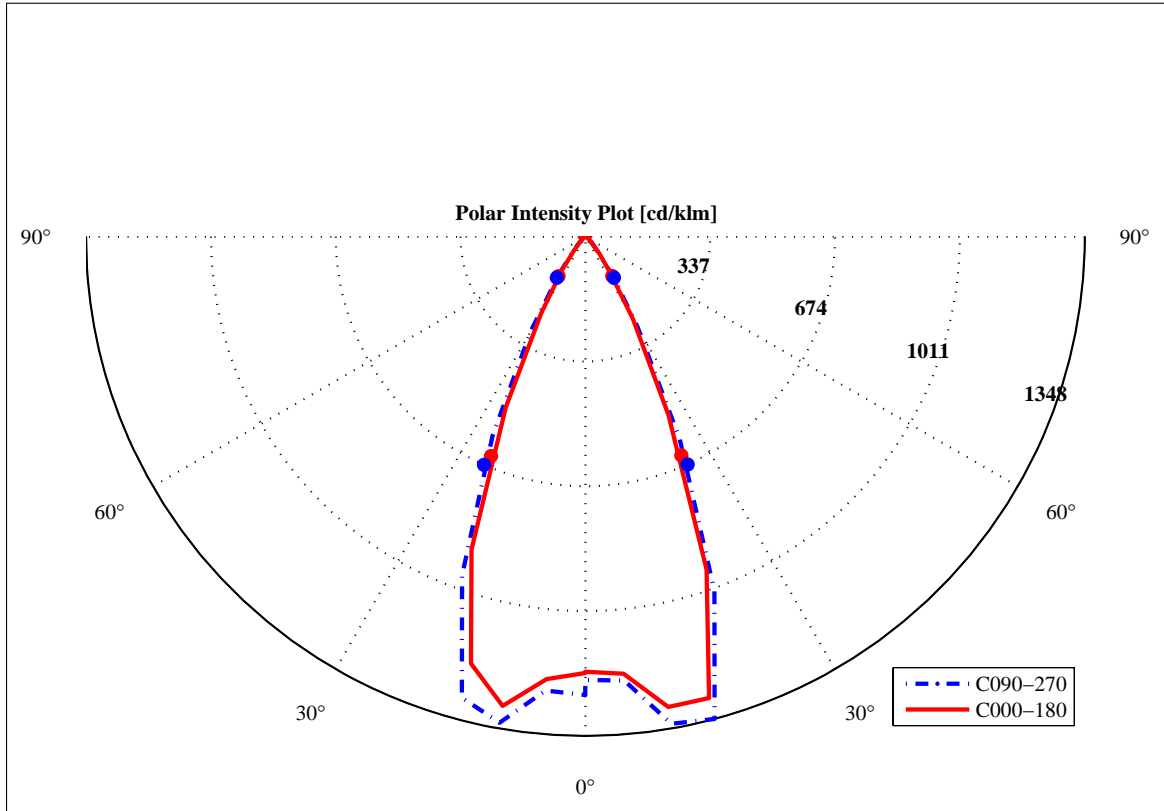

## 5 Illuminance Map

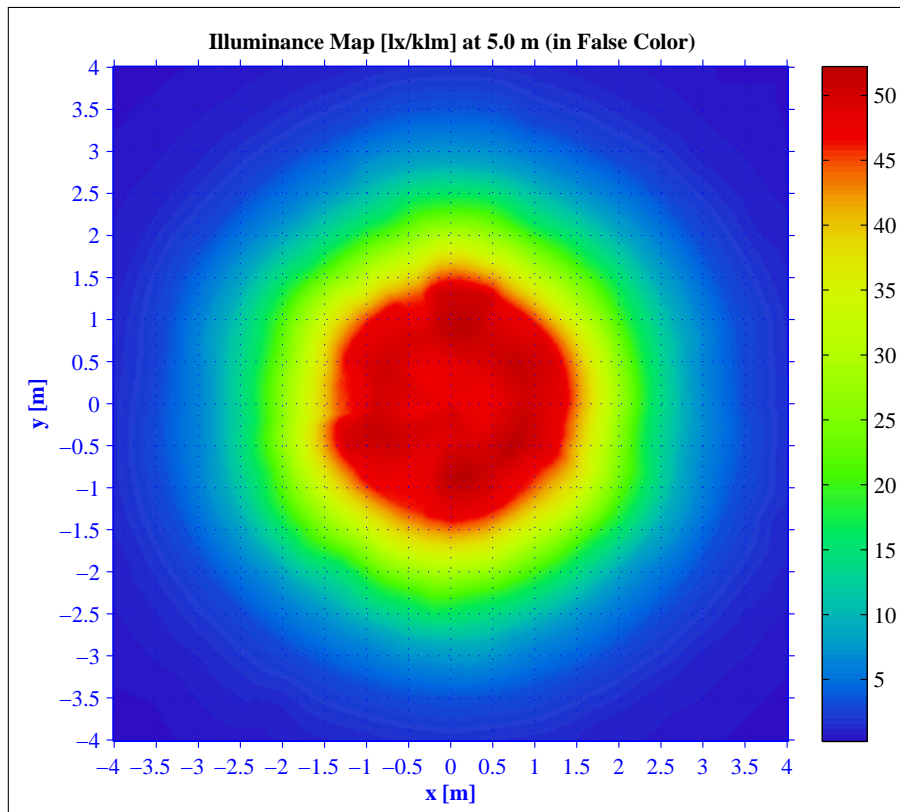
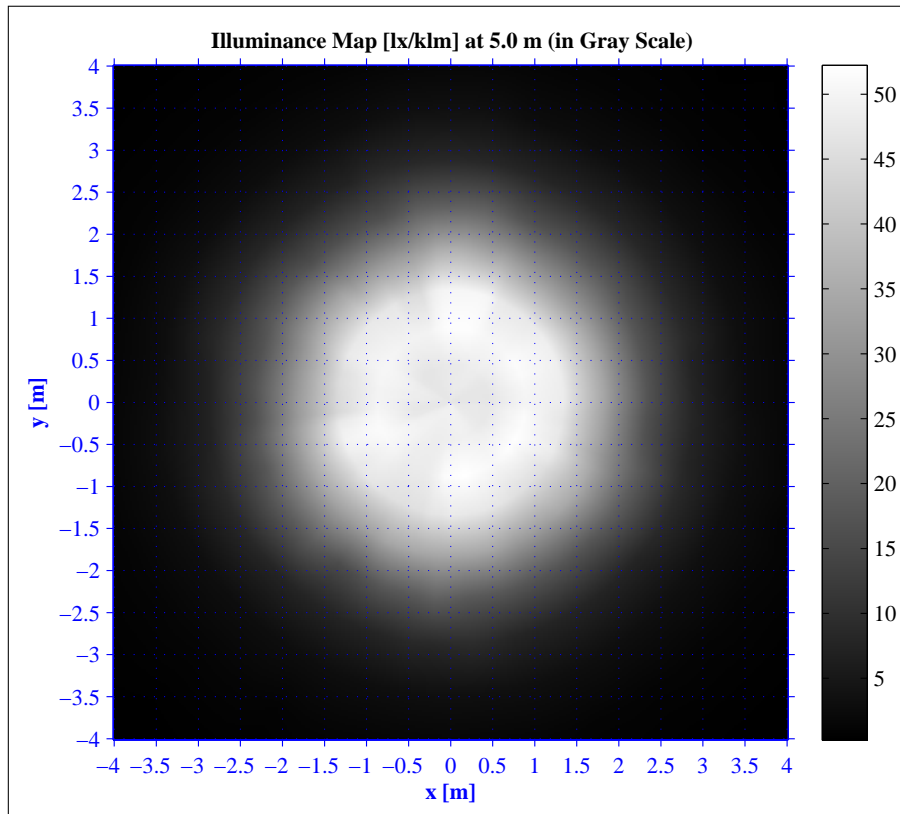



## 7 Illuminance Diagram

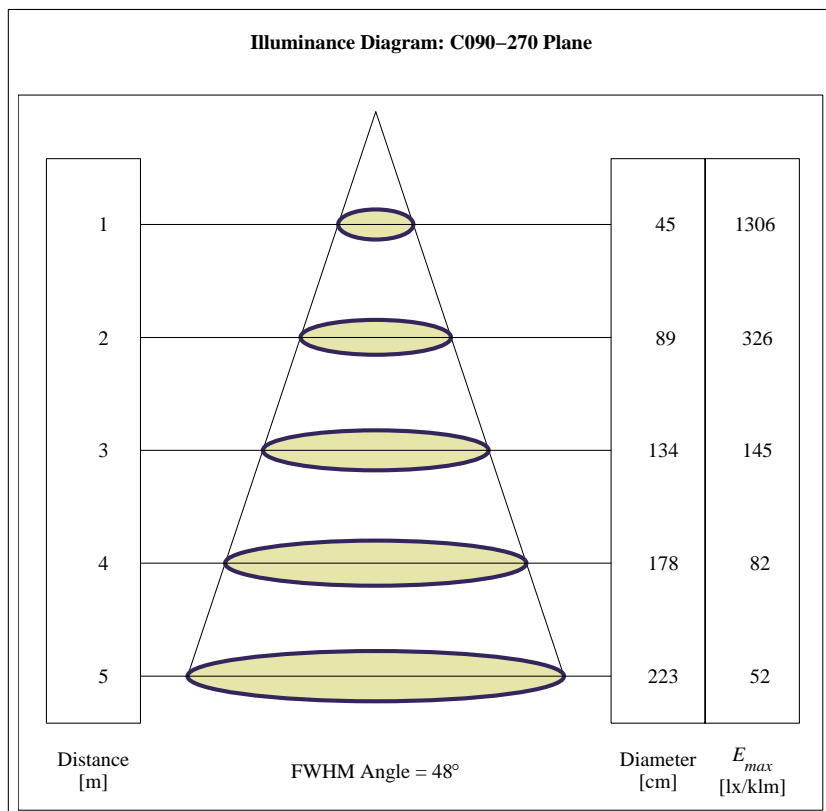
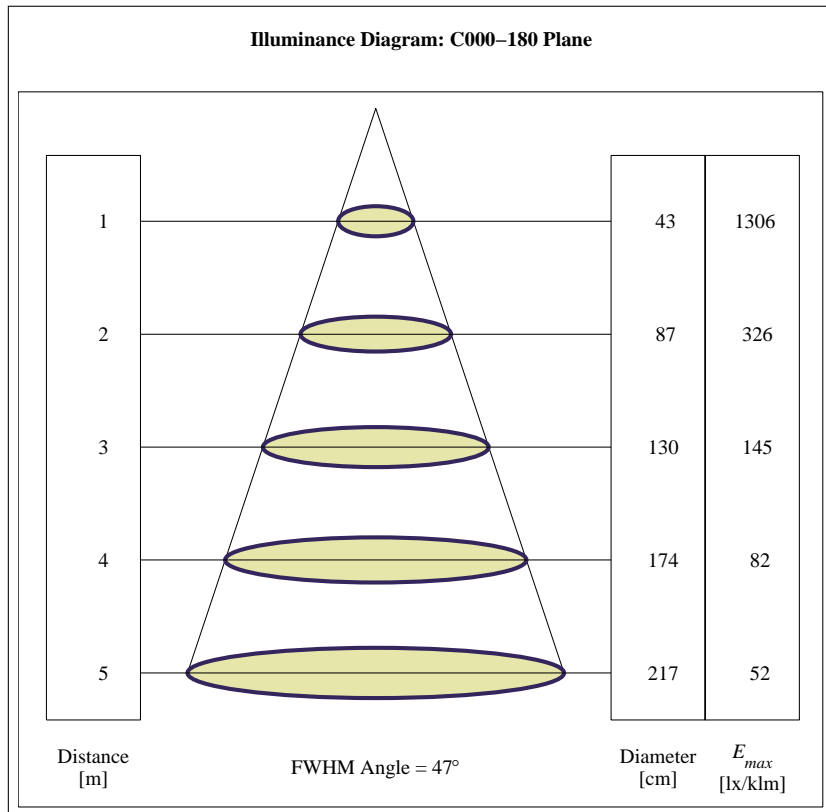

# 8 Drawing

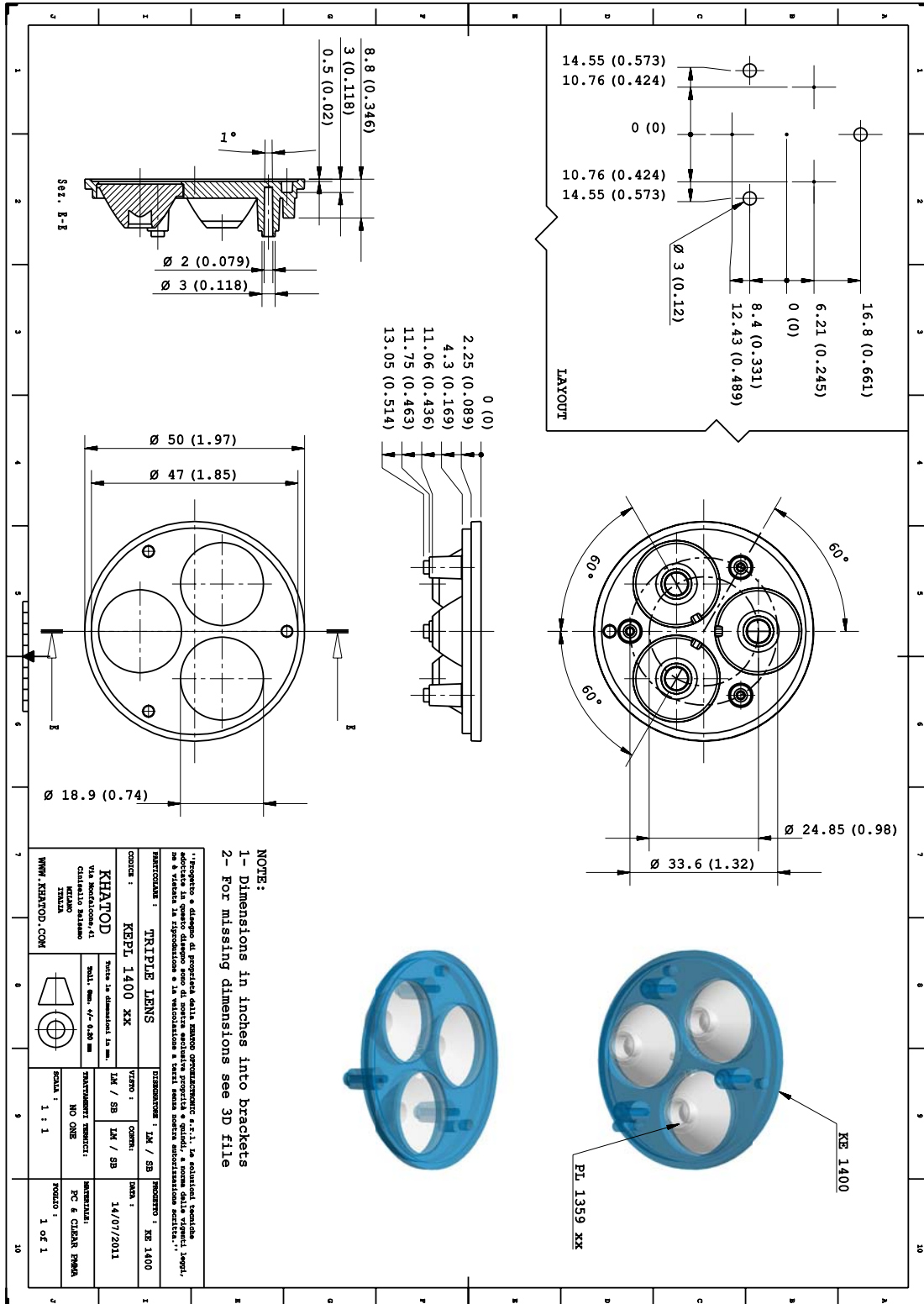



## 9 Use and Maintenance

### Lens characteristics

| Parameter             | Symbol      | Rating     | Unit |
|-----------------------|-------------|------------|------|
| Lens Material         | PMMA Optics | --         | --   |
| Holder Material       | PC          | --         | --   |
| Operating Temperature | Topr        | -30 to +85 | °C   |
| Storage Temperature   | Tstg        | -30 to +85 | °C   |

### Notes:

Please note that flow lines and weld lines on the external surfaces of the lenses are acceptable if the optical performance of the lens is within the specification described in the section "OPTICAL CHARACTERISTICS"

- Should you require further information, please contact Khatod for advice.
- All lens testing must be subject to identical conditions as Khatod test condition.
- Published by Khatod optoelectronic srl - All the data contained in this document are the property of Khatod optoelectronic srl and may change without notice.

### **KHATOD LENS Use And Maintenance**

- DO NOT HANDLE OR INSTALL LENSES WITHOUT WEARING GLOVES, SKIN OILS MAY DAMAGE LENS OR LIGHT TRANSMISSION
- CLEAN LENSES WITH MILD SOAP AND WATER AND A SOFT CLOTH
- DO NOT USE ANY COMMERCIAL CLEANING SOLVENTS ON LENSES

Khatod SRL, Milan, Italy, manufactures lenses for LEDs. Any other use of the lens shall void our liability and warranty. The lenses are an inert component to be used in the manufacture of various products. Our warranty and liability are limited only to the manufacture of the lens. You may not modify, copy, distribute reproduce, license or alter the lens and related materials of Khatod SRL. Khatod SRL does not warrant against damages or defects arising out of the use or misuse of the products; against defects or damage arising from improper installation, or against defects in the product or in its components. No warranty of any kind, expressed or implied, is made regarding the safety of the products. The entire risk as to the quality or performance of the product is with the buyer. In no event shall Khatod SRL be liable for any direct, indirect, punitive, incidental, special, consequential damages, or any damages whatsoever arising out of or connected with the use or misuse of the product. Khatod SRL shall not have any obligation with respect to the product or any part thereof, whether based on contract, tort, strict liability or otherwise. Buyer assumes all risks and liability from use of the product. The laws of Milan, Italy govern this product warranty and liability and you hereby consent to the exclusive jurisdiction and venue of courts in Milan, Italy in all disputes arising out of or relating to the use of this product. Production, marketing, distribution, sale of these products as well as their possible modifications and variations are only exclusive right of Khatod Optoelectronic S.r.l.

No company can perform any of these actions without written permission released by Khatod Optoelectronic S.r.l. - REPRODUCTION PROHIBITED -