

KCLP4805CRSM - Wide Beam - NEMA 5

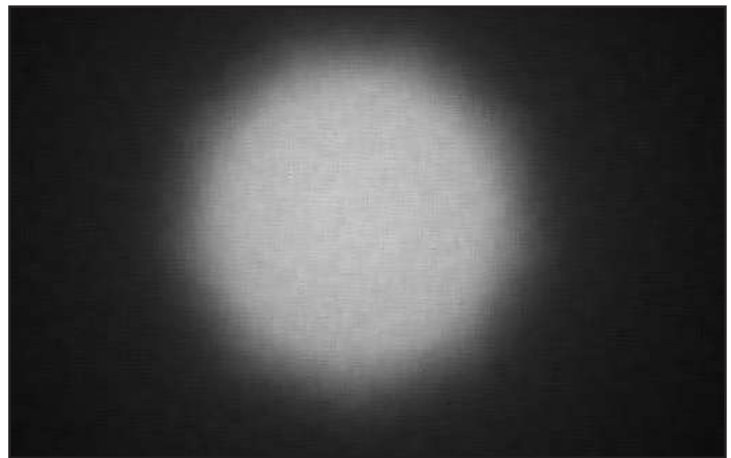

- Material = PC HT Black + Aluminium Reflective Coating (UL94 V0 on Request)
- Efficiency: over 94%
- Full angle at 50% from maximum: ~ 40°
- Full angle at 10% from maximum: ~ 88°
- The light spots here represented refer to tests carried out with LEDs with 3mm dome and 2mm² LES, ~260lm@LED

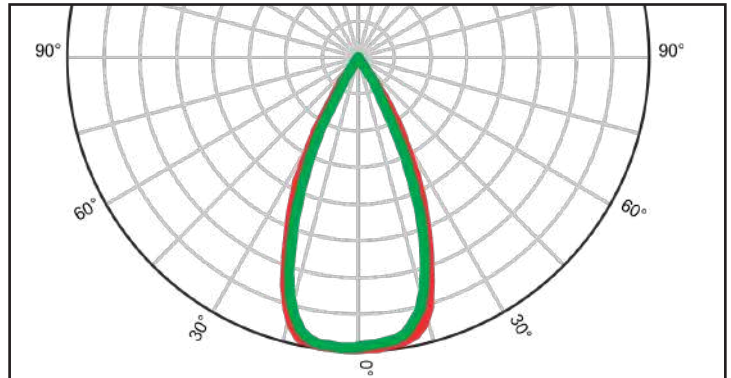
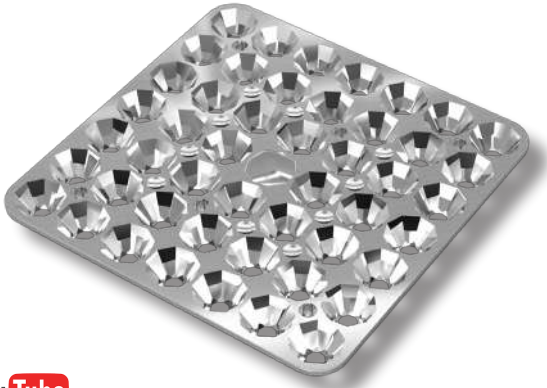
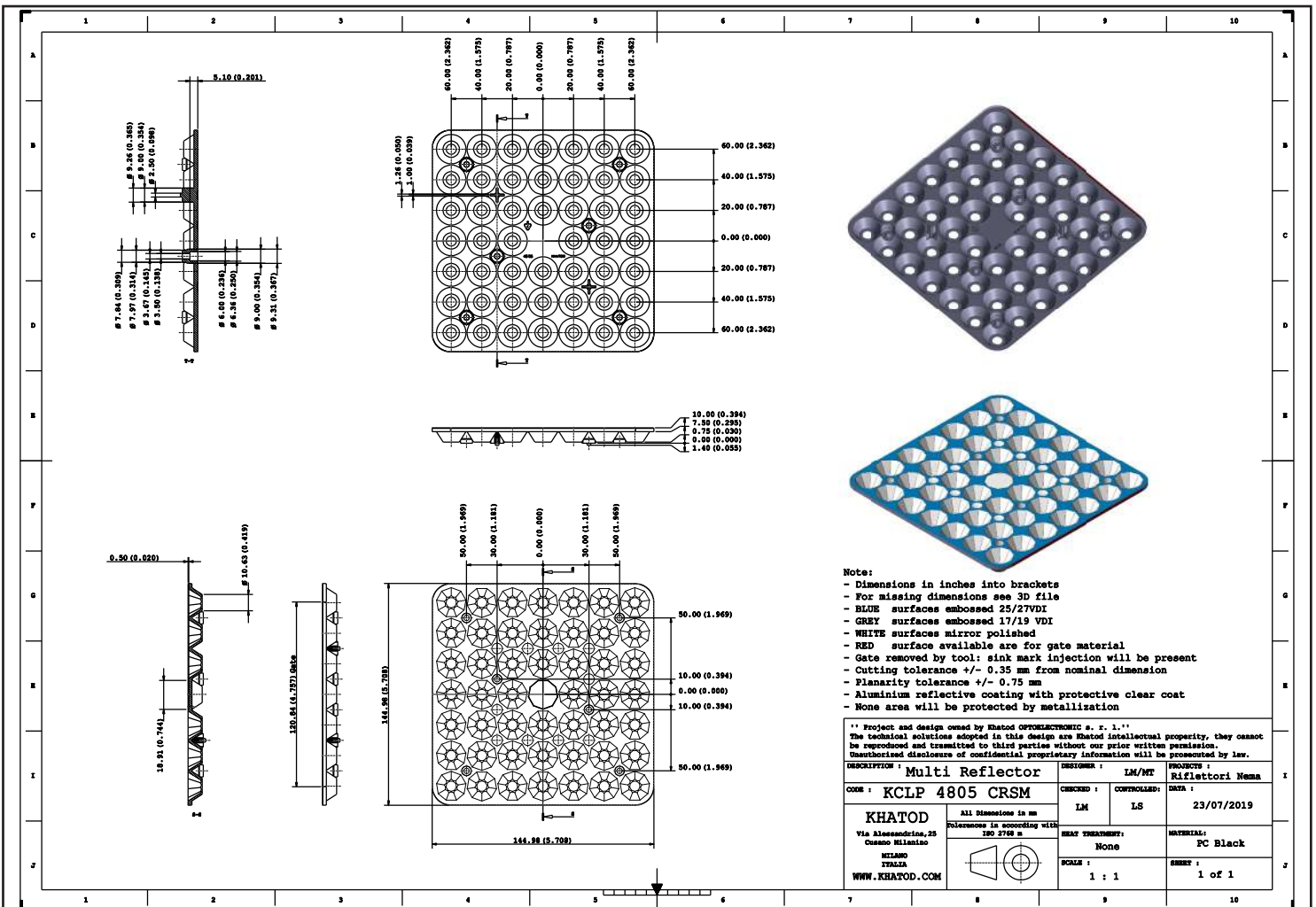

KCLP48CV01



- Material = PC 5.0 Clear, (UL94 V0 on Request)
- Cover Per KCLP4801CRSM
- Silicone Gasket already applied
- IK10 - IPx5

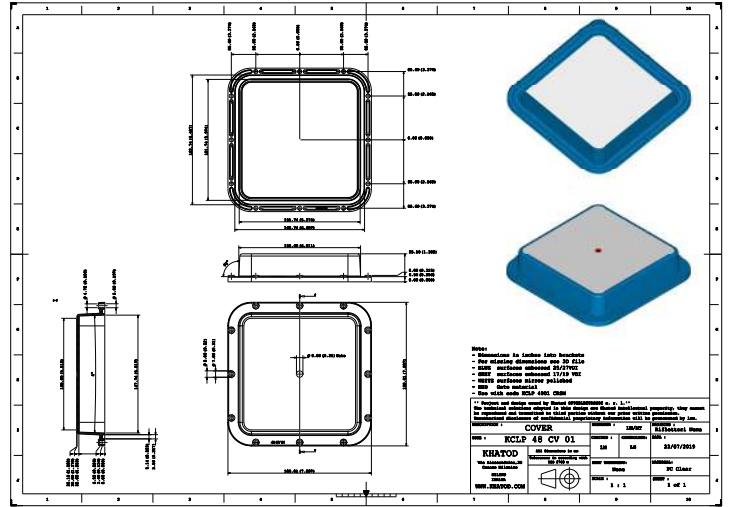

KCLP48CV02

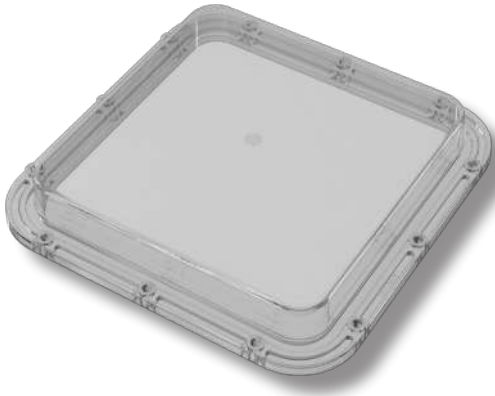

- Material = PC 5.0 Clear, (UL94 V0 on Request)
- Cover Per KCLP4802CRSM, KCLP4803CRSM
- Silicone Gasket already applied
- IK10 - IPx5

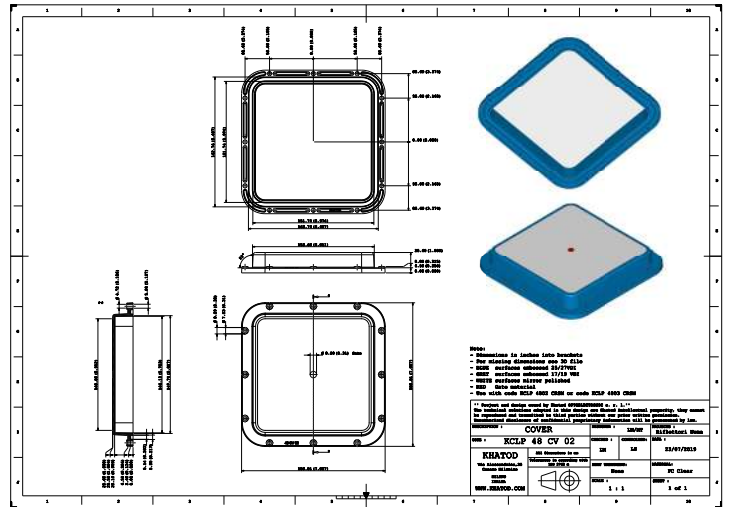

KCLP48CV03

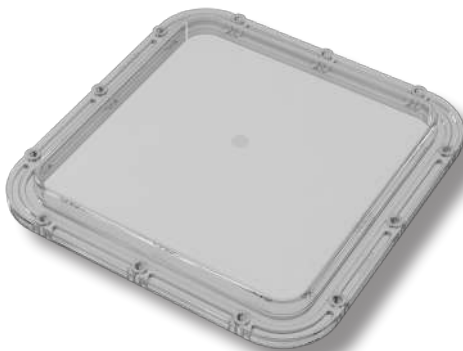

- Material = PC 5.0 Clear, (UL94 V0 on Request)
- Cover Per KCLP4804CRSM, KCLP4805CRSM, KCLP4806CRSM
- Silicone Gasket already applied
- IK10 - IPx5

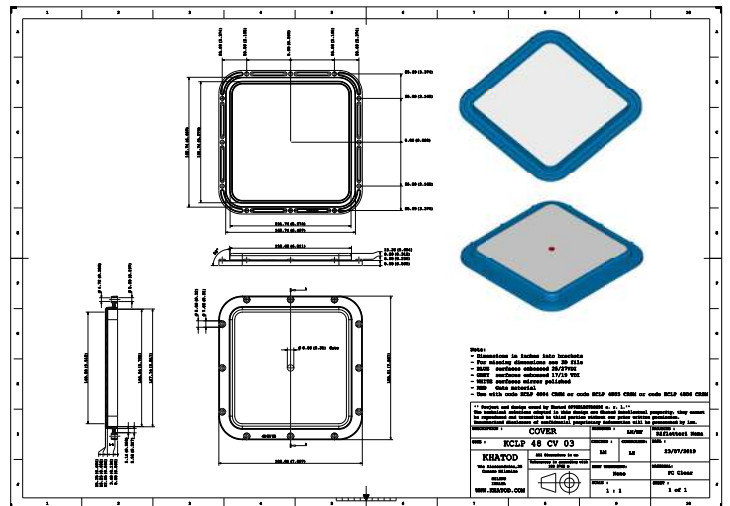

KCLP4805CRSM + KCLP48CV03 - Wide Beam - NEMA 5

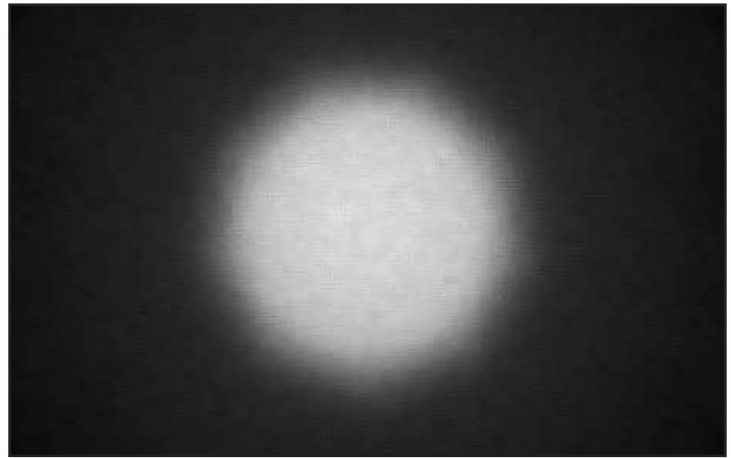
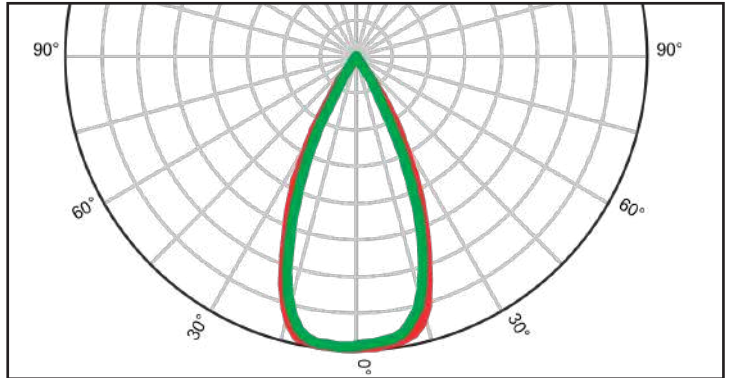

- Efficiency: over 89%
- Full angle at 50% from maximum: ~ 39°
- Full angle at 10% from maximum: ~ 88°
- The light spots here represented refer to tests carried out with LEDs with 3mm dome and 2mm² LES, ~260lm@LED
- IK10
- IPx5

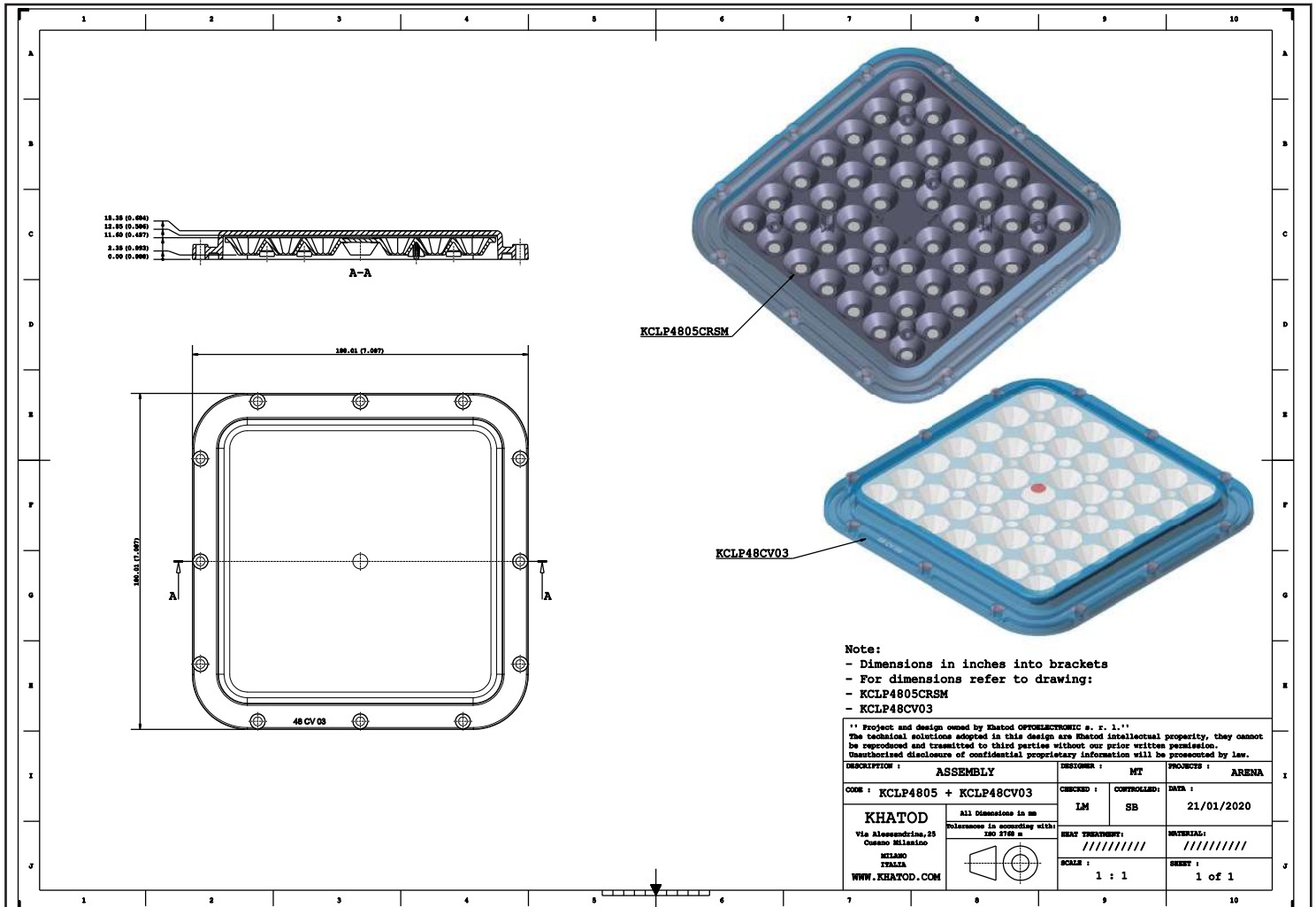

Silicone Gasket



Silicone Gasket already applied, IPX5

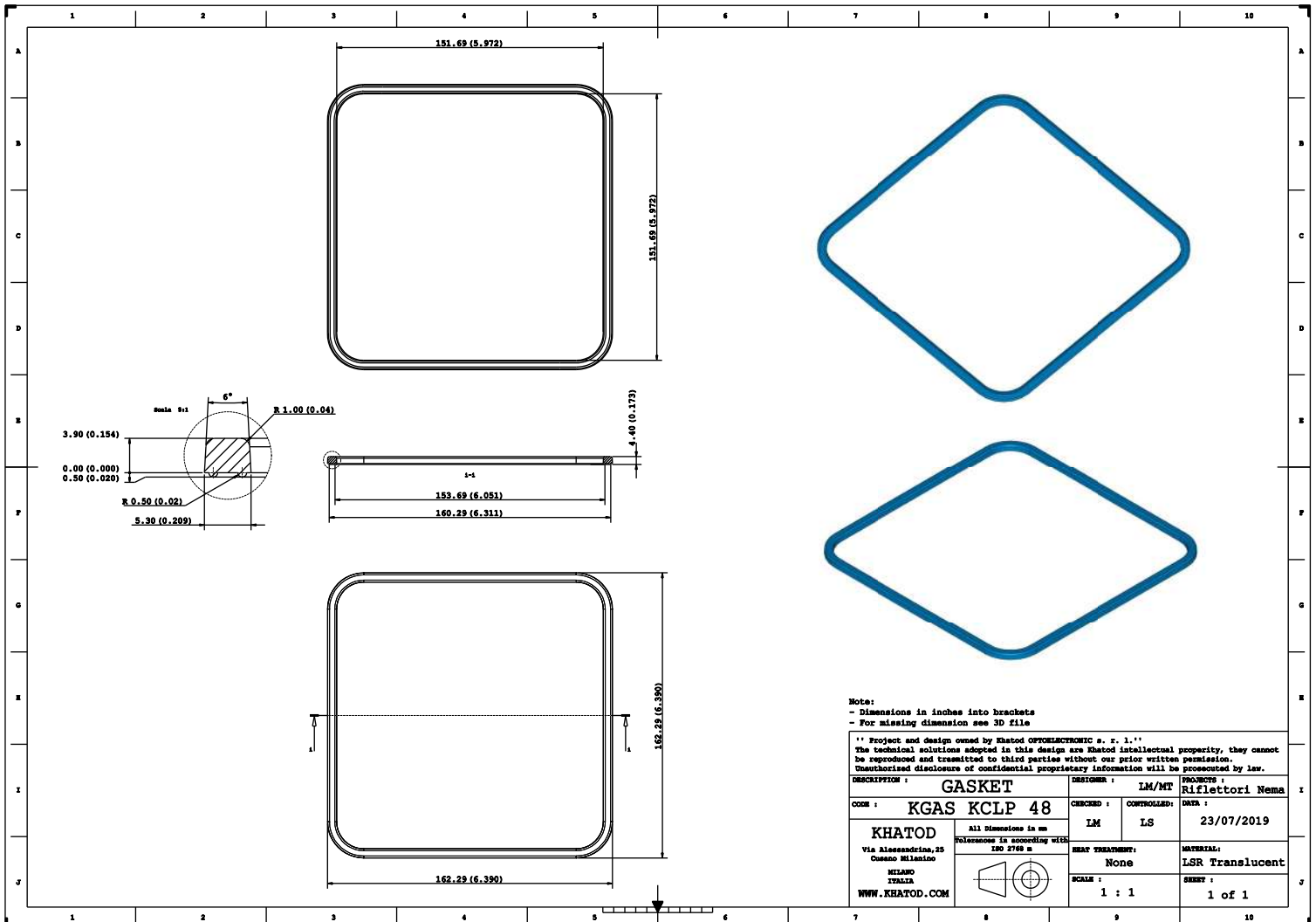

Test circuits made by Khatod

To make the tests easier for the customers, Khatod has created a PCB: KFP43
Circuit diagrams and photos are shown below.

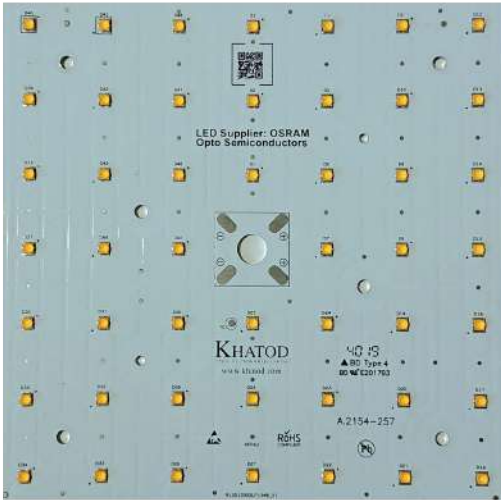

KFP43

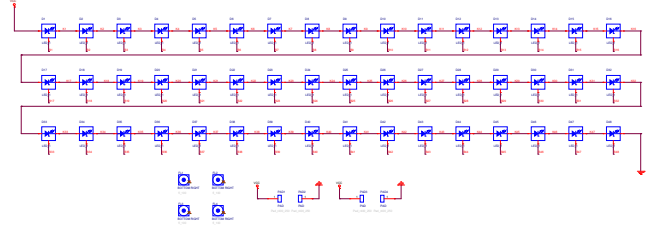

Example using 48 Osram Osolon GW CSSRM2.EM
~ 100Watt
~ 14.400 Lumen

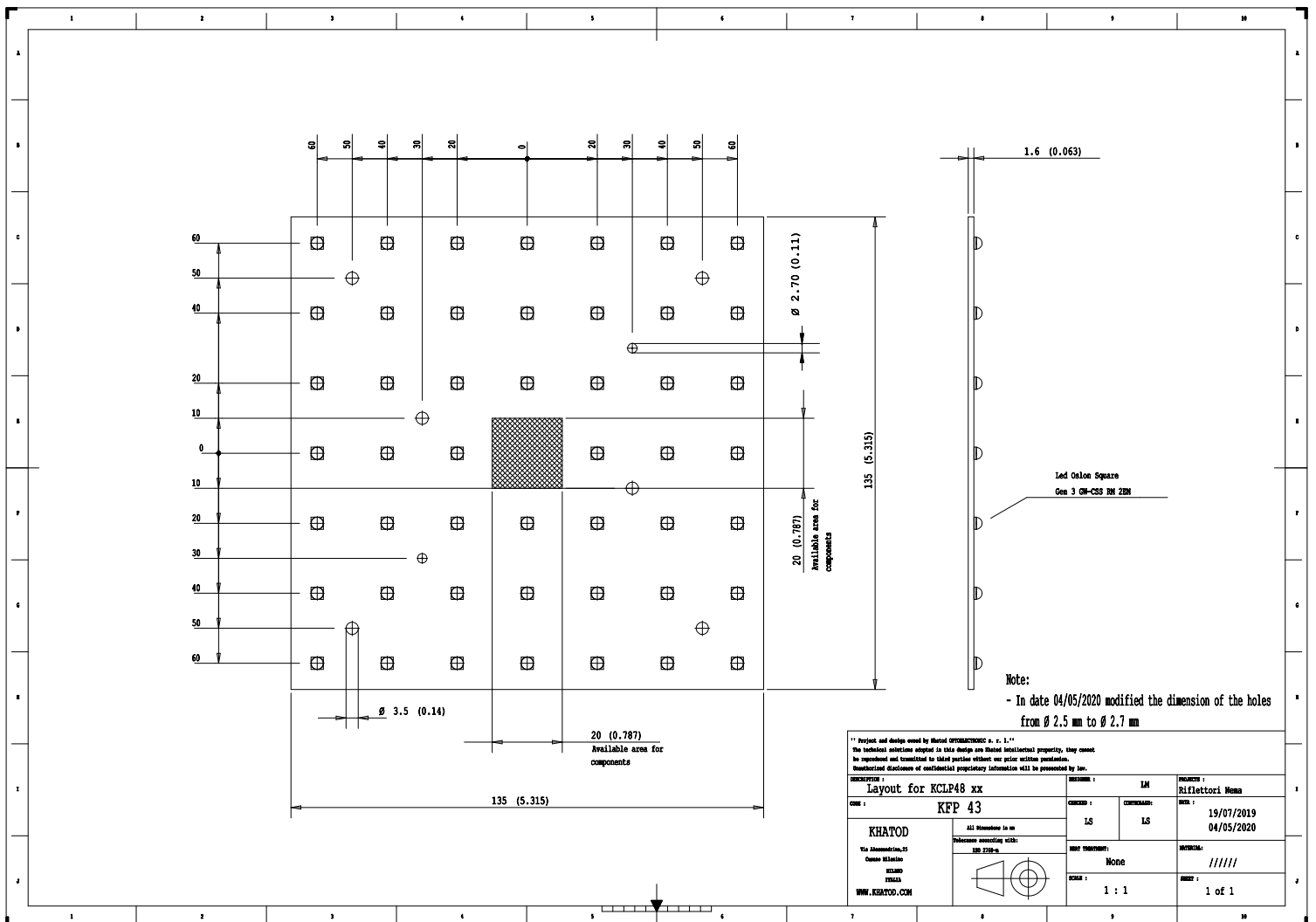

Assembly Specifications

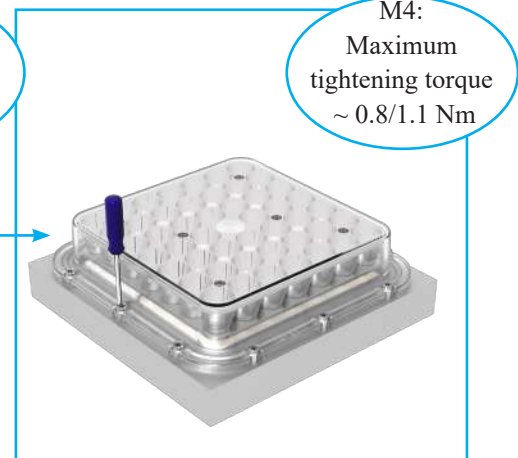
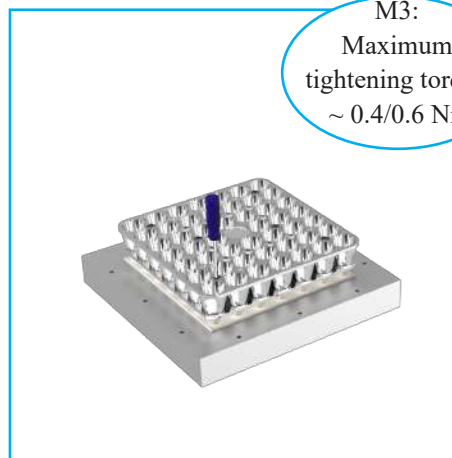
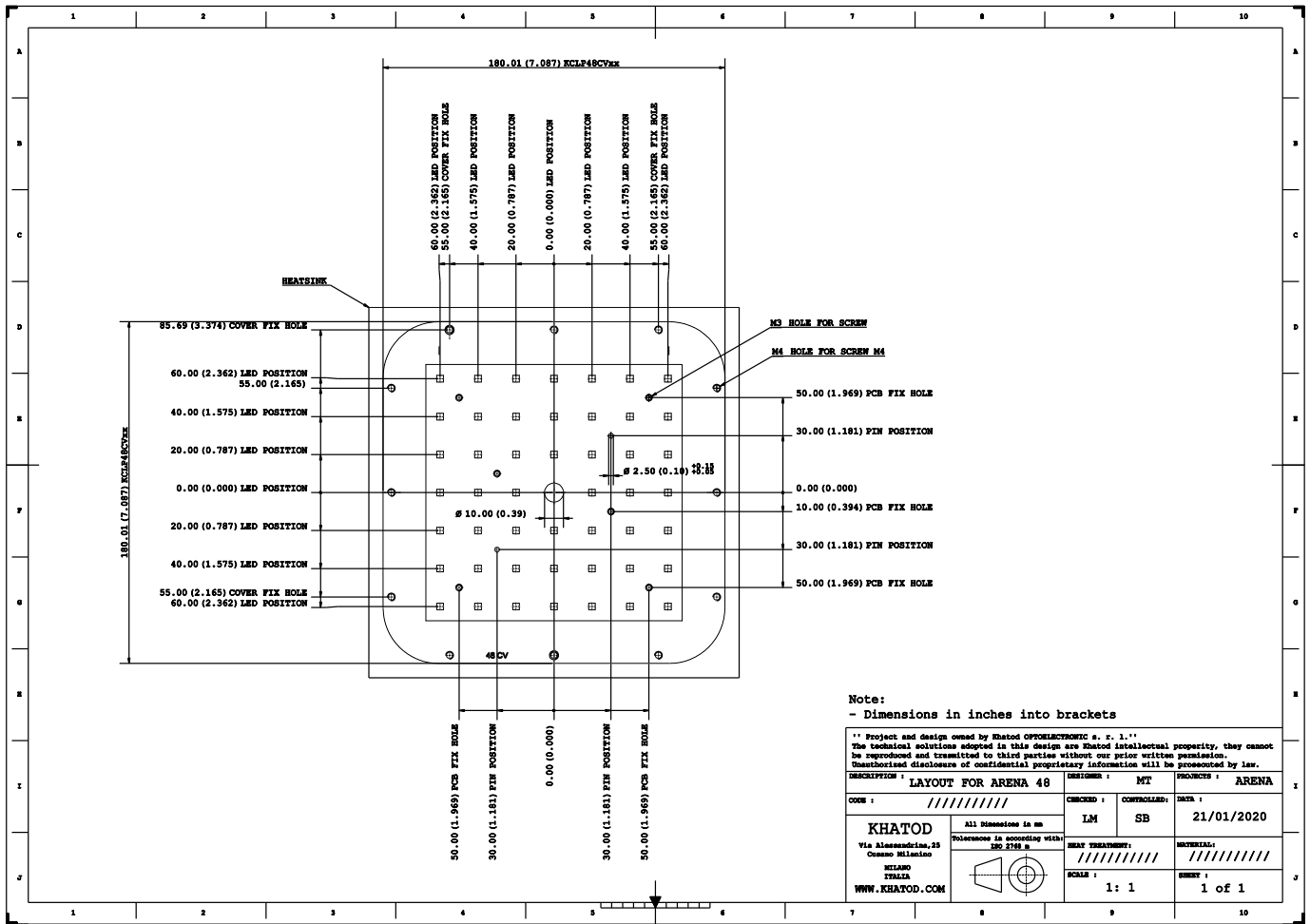

Determination of thermal shock resistance degree

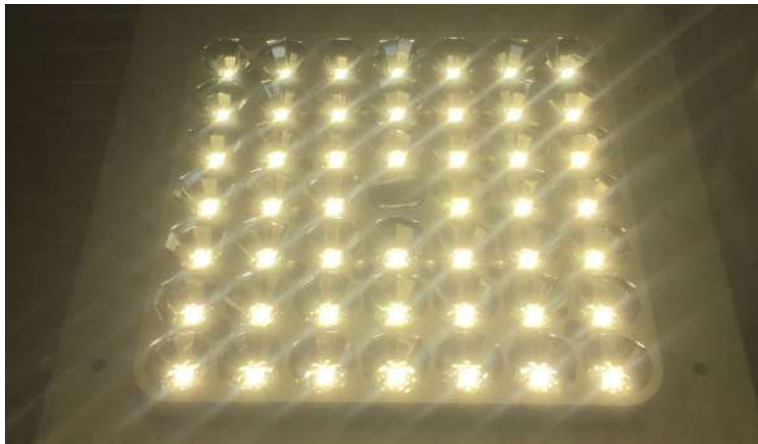

Initial Visual Inspection

Before starting with testing, a visual inspection was performed in order to check the integrity of the part under test.

The part resulted physically intact.

Photo: the part in the climatic chamber.



Temperature set in the climatic chamber

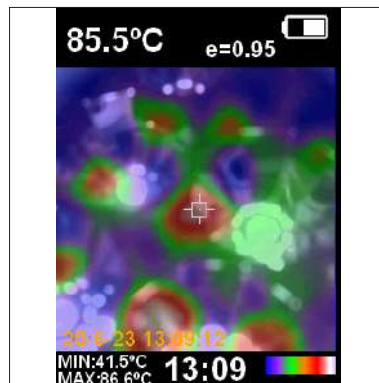

Temperature detected on the part by IR thermal camera

The temperature test was performed to detect the sealing degree of the material. The reference temperature of the component under test is 60° C, and the test was performed with the PCB turned on. Reference PCB: 48 Osram LEDs Oslon Square Gen3, current driven 700mA.

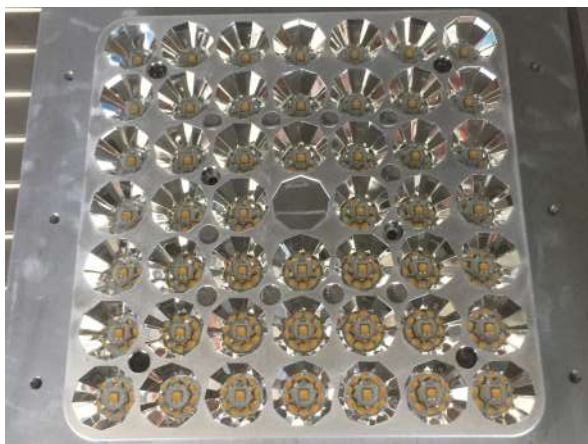

Final Visual Inspection

After testing, a final visual inspection was performed. The result was positive. (view photo)

Photo: the part in the climatic chamber after testing.

The executed tests show that KCLP48xxCRSM moulded in PC, passed the thermal stress tests without any physical deterioration of the material

IK Test - Determination of Mechanical Impact Resistance Degree

Note

The present document is an internal document showing the tests carried out by Khatod in its laboratory. The tests, photos and videos presented in this document are made available for demonstration purposes only. Khatod, with its laboratory, is not a certification body. If customers need IK accredited certifications, they have to apply to the appointed Certification Bodies, under their sole care and responsibility.

Initial Visual Inspection

- Before starting with testing, a visual inspection was performed in order to check the integrity of the part under test. The part resulted physically intact.

Tests Execution

Tests were carried out on the part under test according to IK10 (20 Joule)
Test parameters are as follows:

- Impact energy: 20 Joule
- Impacting element: 5.000 grams
- Distance between impacting element and the part under test: 40 cm
- Number of impacts: 5

1st impact test

2nd impact test

3rd impact test

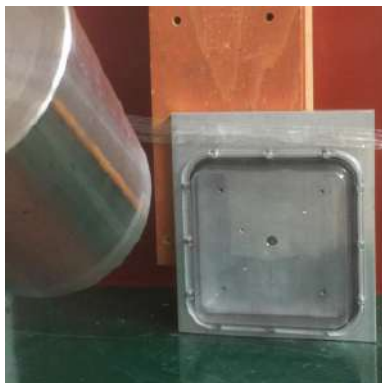
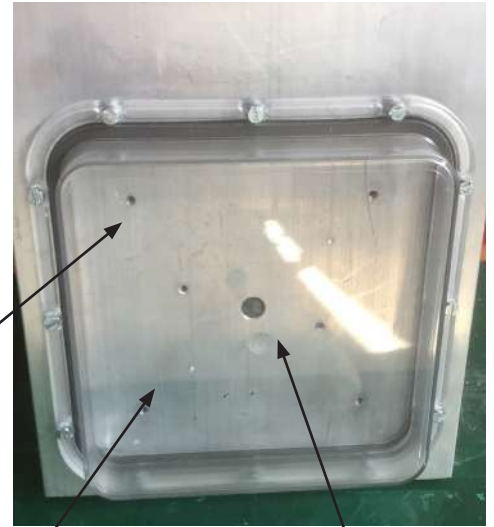

1st TEST



2nd TEST

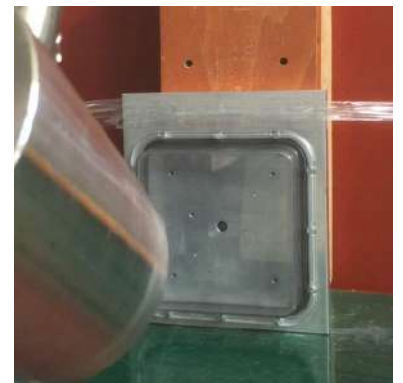

3rd TEST



Final Visual Inspection:
After testing, a final visual inspection was performed.
The result was positive. (view photo)

IP X5 Test

Note

The present document is an internal document showing the tests carried out by Khatod in its laboratory. The tests, photos and videos presented in this document are made available for demonstration purposes only. Khatod, with its laboratory, is not a certification body.

If customers need IP accredited certifications, they have to apply to the appointed Certification Bodies, under their sole care and responsibility.

Data and Analysis

The sample has been subjected to the water-penetration resistance test as follows:

- Assembly of the components to test :
A moisture indicator paper sheet has been interposed between the lens and the clamping base
- Positioning of the assembled sample under the watering device with nozzle Ø 6.3 millimeters
- Water flow: 12.5 l/min ± 5%
- Water pressure: 30 kPa @ distance of 3m
- Duration of water spraying test on the wrap surface per m² : 1 min
- Minimum duration of the test: 3 min
- Distance between the nozzle and the wrap surface: 2.5 Meters
- Torque: 0,7 Nm.



KCLP48CVxx Assembled



Test Under Water Jet



Test Under Water Jet

Conclusion



The test paper sheet is dry

As shown in the photo, the test paper sheet is completely dry after disassembling the system.

Based on the water penetration resistance test, we can say that the Silicone Gasket KGASKCLP48 proved to be fit for purpose. The product has passed the Khatod test.

Application Examples

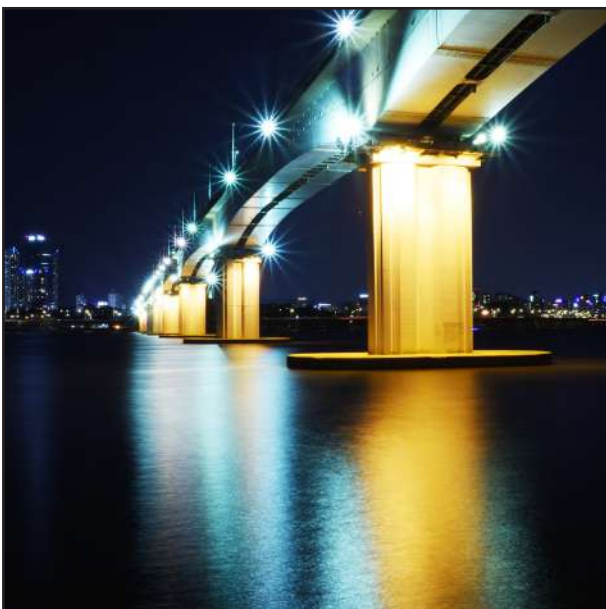

Packaging

KCLP48CV01

Item	Quantity	Total Parts	Size (L*W*H)	G.W.
Package box	7 pcs per box	7 pcs	32*19*20 cm	1.5 Kg
Outer Box	4 package boxes per Outer Box	28 pcs	39*34*42 cm	6.0 Kg

KCLP48CV02

Item	Quantity	Total Parts	Size (L*W*H)	G.W.
Package box	10 pcs per box	10 pcs	32*19*20 cm	1.7 Kg
Outer Box	4 package boxes per Outer Box	40 pcs	39*34*42 cm	6.8 Kg

KCLP48CV03

Item	Quantity	Total Parts	Size (L*W*H)	G.W.
Package box	15 pcs per box	15 pcs	32*19*20 cm	2.3 Kg
Outer Box	4 package boxes per Outer Box	60 pcs	39*34*42 cm	10.0 Kg

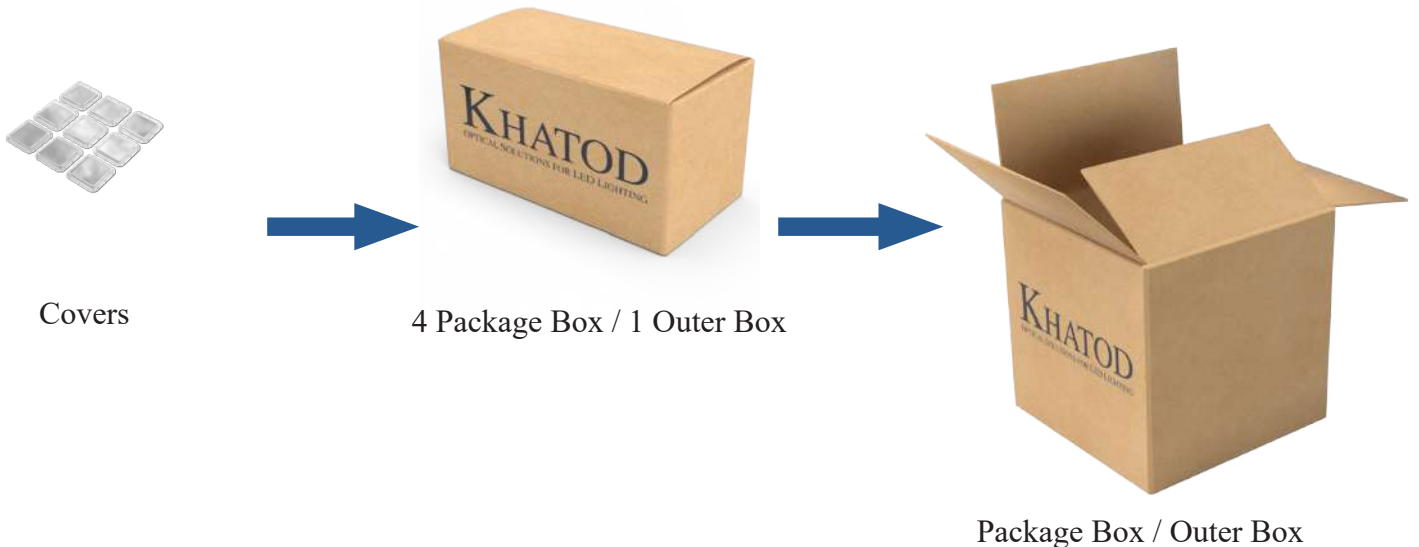

Packaging

KCLP4801CRSM

Item	Quantity	Total Parts	Size (L*W*H)	G.W.
Package box	7 pcs per box	7 pcs	32*19*20 cm	1.9 Kg
Outer Box	4 package boxes per Outer Box	28 pcs	39*34*42 cm	8.1 Kg

KCLP4802CRSM

Item	Quantity	Total Parts	Size (L*W*H)	G.W.
Package box	10 pcs per box	10 pcs	32*19*20 cm	1.6 Kg
Outer Box	4 package boxes per Outer Box	40 pcs	39*34*42 cm	6.7 Kg

KCLP4803CRSM

Item	Quantity	Total Parts	Size (L*W*H)	G.W.
Package box	15 pcs per box	15 pcs	32*19*20 cm	1.9 Kg
Outer Box	4 package boxes per Outer Box	60 pcs	39*34*42 cm	8.3 Kg

KCLP4804CRSM / KCLP4805CRSM / KCLP4806CRSM

Item	Quantity	Total Parts	Size (L*W*H)	G.W.
Package box	20 pcs per box	20 pcs	32*19*20 cm	2.15 Kg
Outer Box	4 package boxes per Outer Box	80 pcs	39*34*42 cm	9.2 Kg



Reflectors



4 Package Box / 1 Outer Box



Package Box / Outer Box

Materials

Material	Top
PC	-40°...120°C
KCLP48xxCRSM Temperature resistance: long-term	-40°...90°C
KCLP48CVxx Temperature resistance: long-term	-40°...90°C
KCLP48CVxx Temperature resistance: short exposure	up to + 115 °C

Notes:

- The optical values shown are the result of optical simulations carried out with LIGHTTOOLS, ASAP and ZEMAX software systems. The optical simulations are carried out on the basis of the typical values provided in the LED manufacturers' official datasheets. The photometric analysis has been carried out on physical samples.

Use and Maintenance

- DO NOT HANDLE OR INSTALL LENSES WITHOUT WEARING GLOVES, SKIN OILS MAY DAMAGE LENS OR LIGHT TRANSMISSION;
- CLEAN LENSES WITH MILD SOAP AND WATER AND A SOFT CLOTH;
- DO NOT USE ANY COMMERCIAL CLEANING SOLVENTS ON LENSES.

Disclaimer

Please note that flow lines and weld lines on the external surfaces of the lenses are acceptable if the optical performance of the lens is within the specifications.

Should you require further information, please contact Khatod for advice. All lens testing must be subject to identical conditions as Khatod test condition. Khatod Optoelectronic, Milan, Italy, manufactures lenses for LEDs. Any other use of the lens shall void our liability and warranty. The lenses are an inert component to be used in the manufacture of various products. Our warranty and liability are limited only to the manufacture of the lens. You may not modify, copy, distribute reproduce, license or alter the lens and related materials of Khatod. Khatod does not warrant against damages or defects arising out of the use or misuse of the products; against defects or damage arising from improper installation, or against defects in the product or in its components. No warranty of any kind, expressed or implied, is made regarding the safety of the products. The entire risk as to the quality or performance of the product is with the buyer. In no event shall Khatod be liable for any direct, indirect, punitive, incidental, special, consequential damages, or any damages whatsoever arising out of or connected with the use or misuse of the product. Khatod shall not have any obligation with respect to the product or any part thereof, whether based on contract, tort, strict liability or otherwise. Buyer assumes all risks and liability from use of the product. The laws of Milan, Italy govern this product warranty and liability and you hereby consent to the exclusive jurisdiction and venue of courts in Milan, Italy in all disputes arising out of or relating to the use of this product. Production, marketing, distribution, sale of these products as well as their possible modifications and variations are only exclusive right of Khatod Optoelectronic. No company can perform any of these actions without written permission released by Khatod Optoelectronic. The information contained in this document is proprietary of Khatod Optoelectronic and may change without notice.

REPRODUCTION PROHIBITED.