



KHATOD

Optics for UV LEDs

KHATOD OPTOELECTRONIC SINCE 1985 - WE MANUFACTURE SOLUTIONS



Khatod Optoelectronic is leader manufacturer of optics for UV LEDs used in LED lighting devices for UV disinfection and sterilization applications. Khatod UV optics improve the performance of UV LEDs and allow the development of highly efficient UV LED lamps, appliances and equipments.

Unique on the international scene, for over thirty-five years Khatod has specified and developed the entire product process 100% in house, Milano, Italy, from initial optical design to the final product, including mould and tooling engineering and manufacturing, product production process, PECVD Plasma metallization process.

We offer the most complete range of optical solutions for LED Lighting and a proven capability to develop custom optics that account for about 40% of total production. Qualified professionals support the customer from initial design and all along the product processing. Our strong vocation to achieve the best result and close collaboration with our partners of the industry are the best guarantee for our customers looking for the most proper optical solution for their requirements.

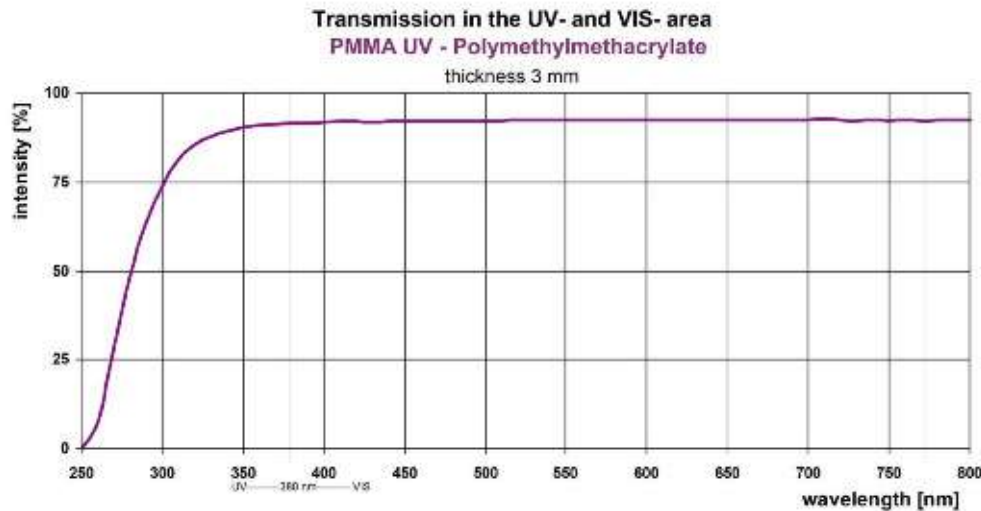

OPTICAL SILICONE LSR 5.0

Optical Properties

- Transmittance over wavelength

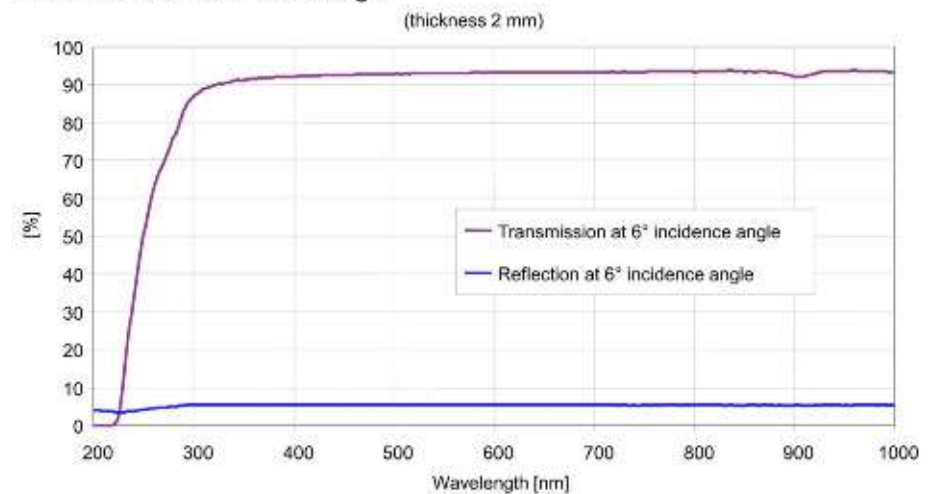

SILICONE OPTICS

OPTICS MADE OF SILICONE FOR UV LEDs, WORKING WITH UVC RADIATION
WORKING RANGE: 250nm - 450nm



SILICONE SINGLE OPTICS
WITH SELF-ADHESIVE TAPE



SI03 JUNIOR



NACTUS 6X2 SIL

PMMA OPTICS

OPTICS MADE OF PMMA FOR UV LEDs, WORKING WITH 405nm RADIATION
WORKING RANGE: 350nm - 450nm



SMILE



SUPERLINEA IP



SUPERLINEA



GRANDE

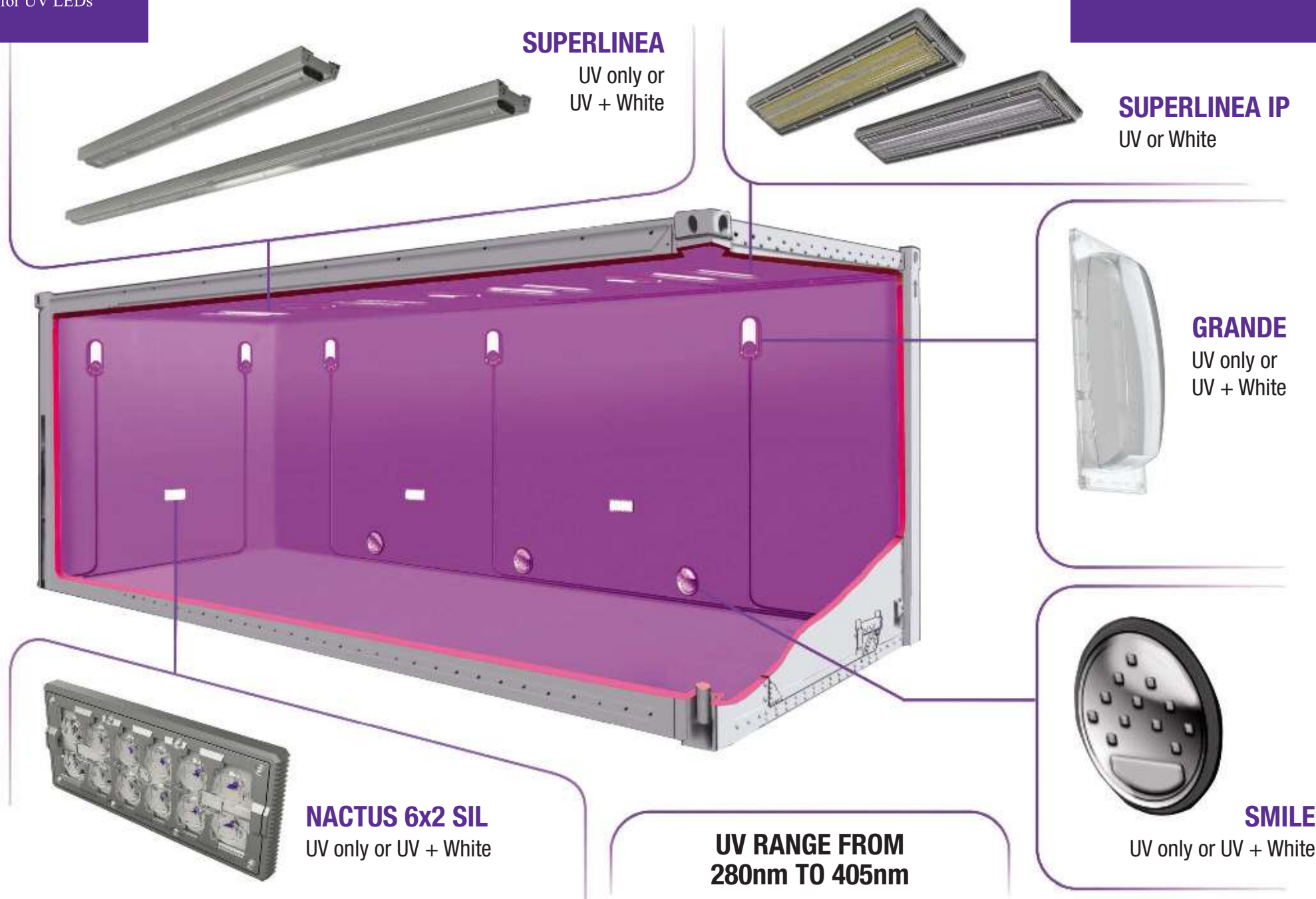

SILICONE SINGLE OPTICS

DESIGNED FOR NEAR FIELD APPLICATIONS
FROM 250nm TO 450nm

DISINFECTION LIGHT

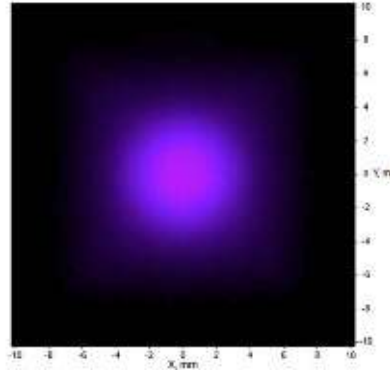

KESQ2145FC25SR

Material: **SILICONE** for the Optic, PC for the Holder
Near Field Applications @ 25mm
Spot Dimension @ 50% of Center Value: ~ 7 mm
Spot Dimension @ 10% of Center Value: ~ 15 mm

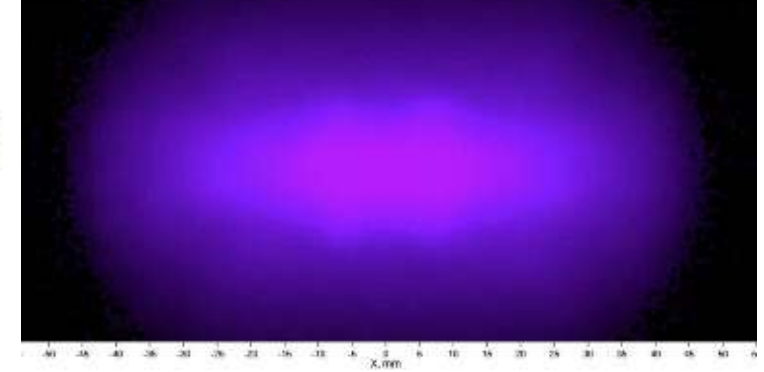

KESQ2145FC100SR

Material: **SILICONE** for the Optic, PC for the Holder
Near Field Applications @ 100mm
Spot Dimension @ 50% of Center Value: ~ 50x25 mm
Spot Dimension @ 10% of Center Value: ~ 75x50 mm

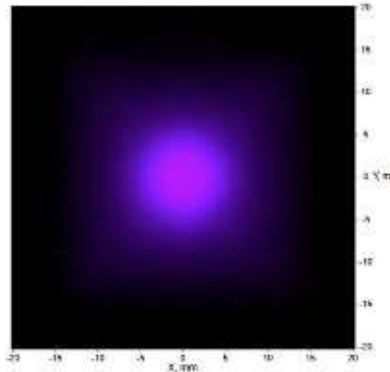

KESQ2145FC50SR

Material: **SILICONE** for the Optic, PC for the Holder
Near Field Applications @ 50mm
Spot Dimension @ 50% of Center Value: ~ 8 mm
Spot Dimension @ 10% of Center Value: ~ 22 mm

APPLICATION EXAMPLES



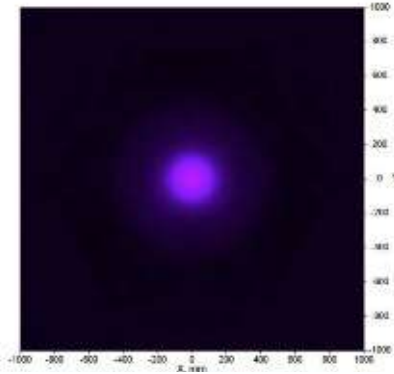

KESQ2145NASR

Material: **SILICONE** for the Optic, PC for the Holder
Far Field Applications @ 1000mm
Full angle C0-C180 at 50% from maximum: ~ 8°
Full angle C0-C180 at 50% from maximum: ~ 16°

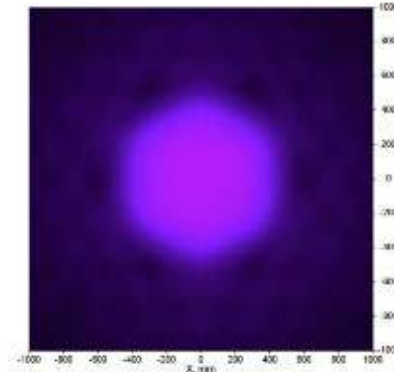

KESQ2145WISR

Material: **SILICONE** for the Optic, PC for the Holder
Far Field Applications @ 1000mm
Full angle C0-C180 at 50% from maximum: ~ 40°
Full angle C0-C180 at 50% from maximum: ~ 55°

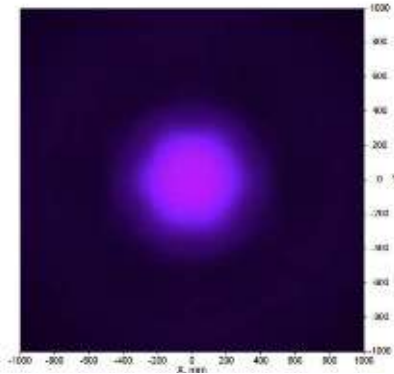

KESQ2145MESR

Material: **SILICONE** for the Optic, PC for the Holder
Far Field Applications @ 1000mm
Full angle C0-C180 at 50% from maximum: ~ 25°
Full angle C0-C180 at 50% from maximum: ~ 36°

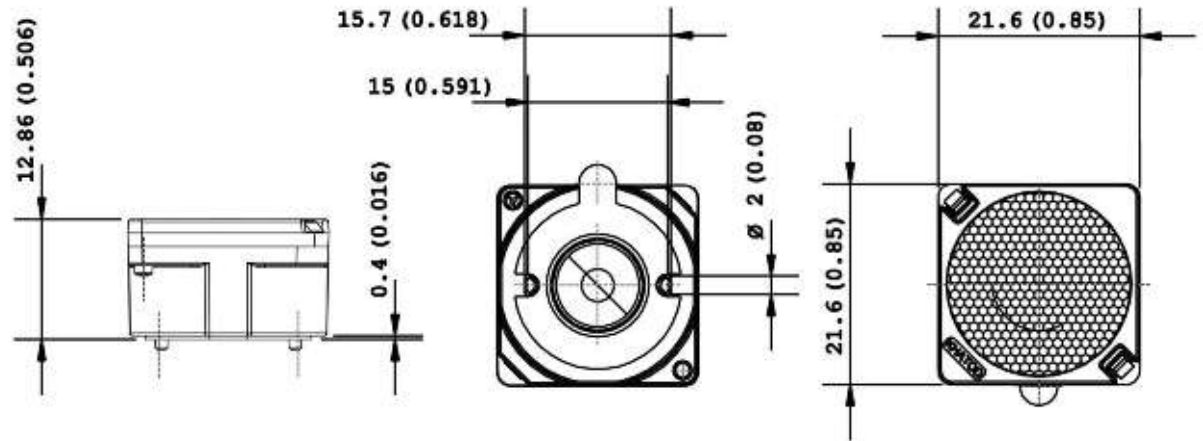

NACTUS 6X2 SIL

OPTICS MADE OF OPTICAL GRADE SILICONE FOR INTERIOR DISINFECTION LIGHT APPLICATIONS. WORKING WITH UVC RADIATION. WORKING RANGE: 250nm - 450nm



DISINFECTION LIGHT



PLL120002SR

Material: **SILICONE** for the Optic,
PC or Aluminium for the Holder
Full angle at 50% from maximum: ~ 150°
Full angle at 10% from maximum: ~ 165°

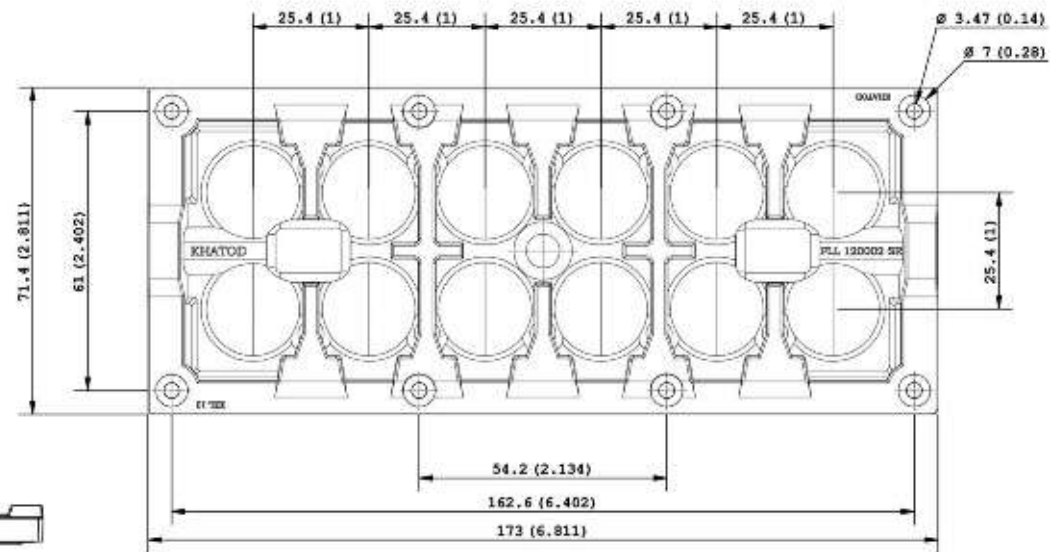
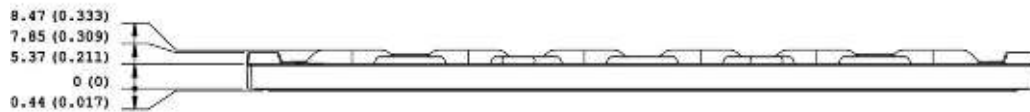
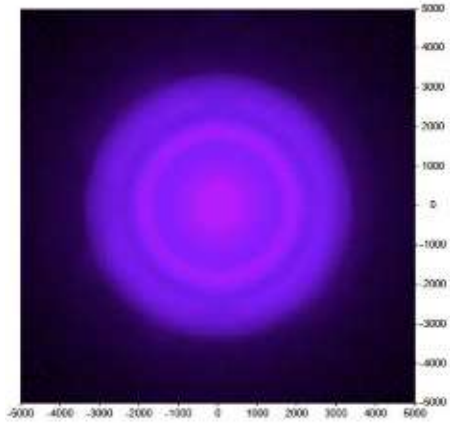
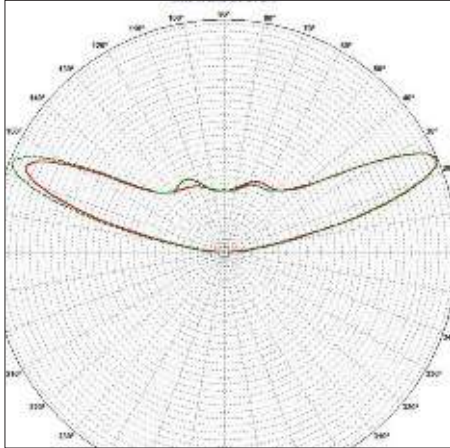

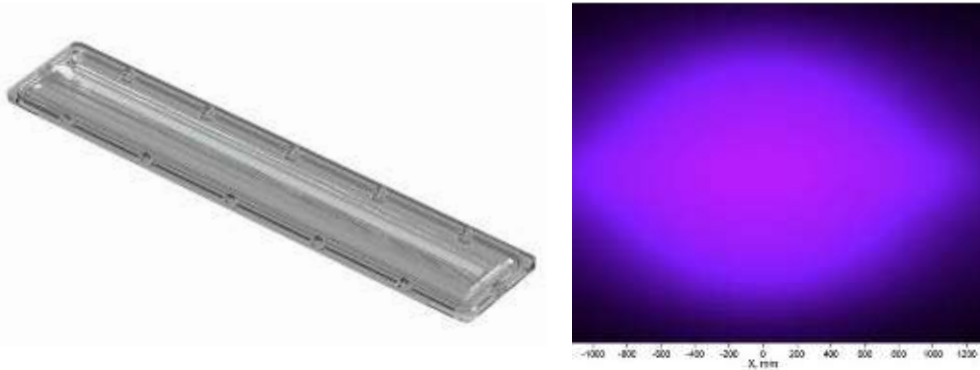

PLL2091EWIPUV

Material: **PMMA UV** for the Optic, Silicone for the Gasket
Full angle C0-C180 at 50% from maximum: ~ 27x100°

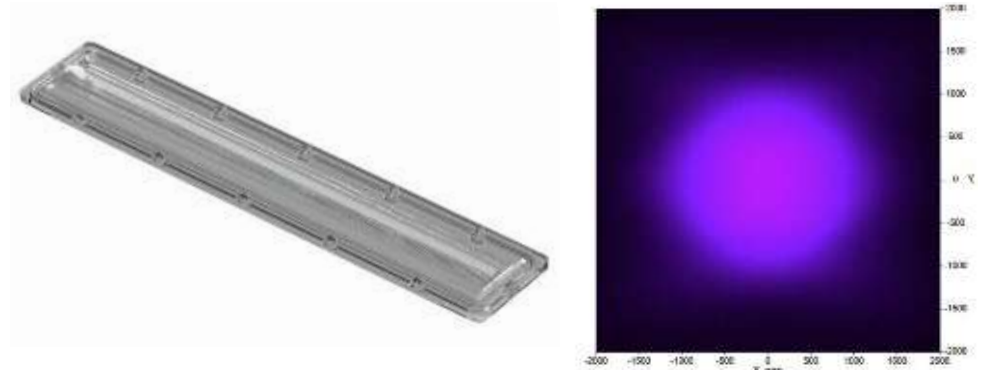

PLL2091UWIPUV

Material: **PMMA UV** for the Optic, Silicone for the Gasket
Full angle C0-C180 at 50% from maximum: ~ 84x100°

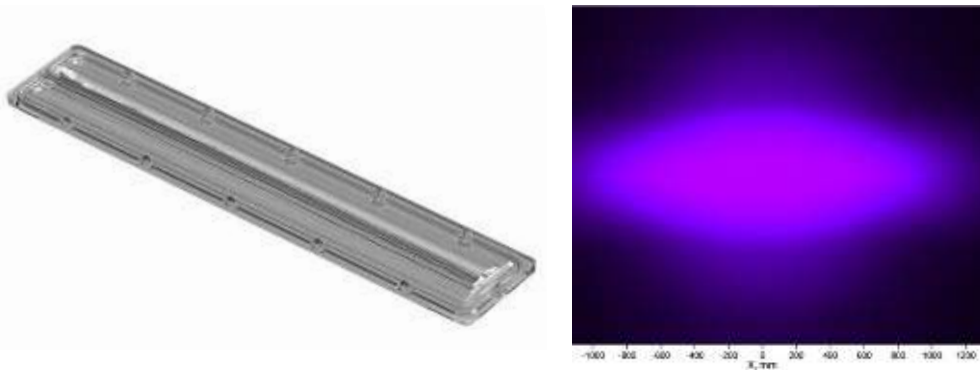

PLL2091WIIPUV

Material: **PMMA UV** for the Optic, Silicone for the Gasket
Full angle C0-C180 at 50% from maximum: ~ 54x100°



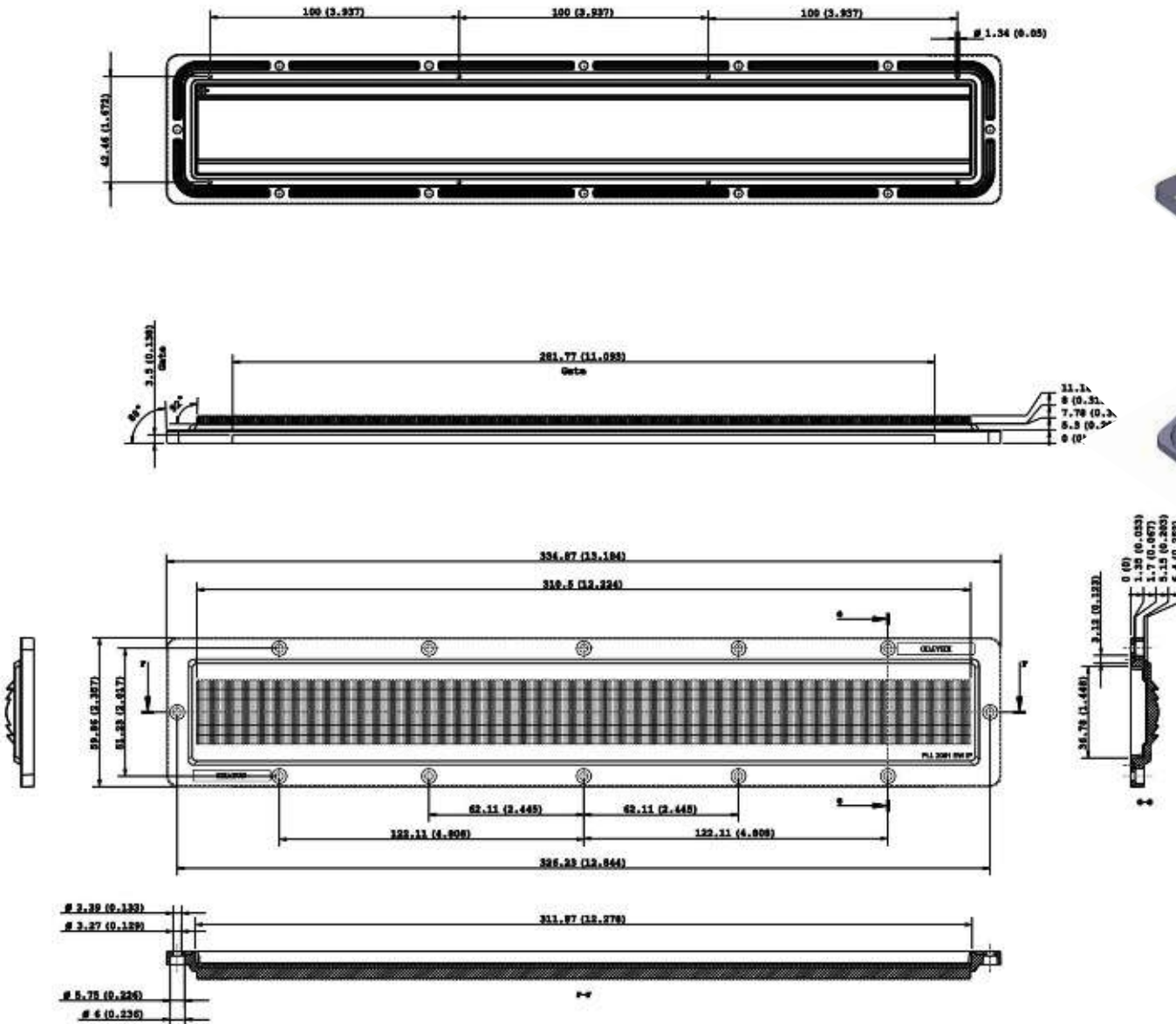

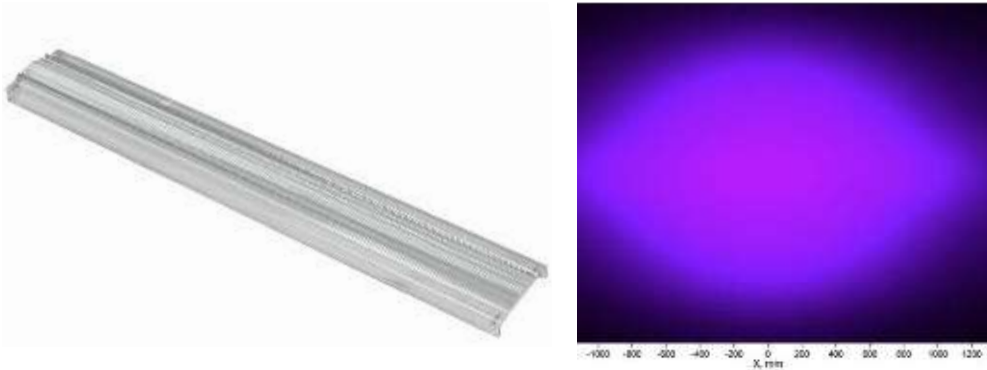

PLL2091EWUV

Material: **PMMA UV**

Full angle C0-C180 at 50% from maximum: ~ 27x100°

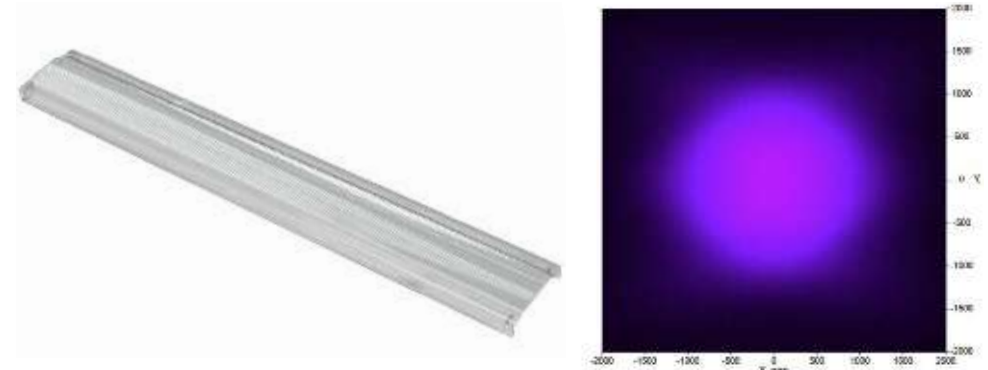

PLL2091UWUV

Material: **PMMA UV**

Full angle C0-C180 at 50% from maximum: ~ 84x100°

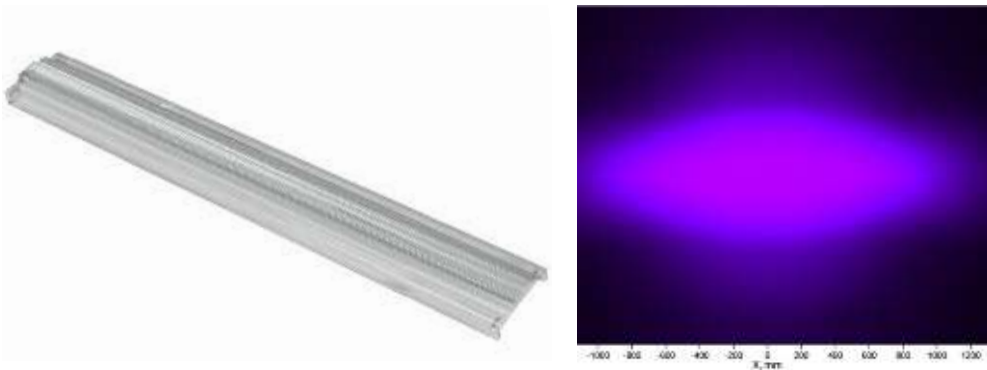

PLL2091WIUV

Material: **PMMA UV**

Full angle C0-C180 at 50% from maximum: ~ 54x100°

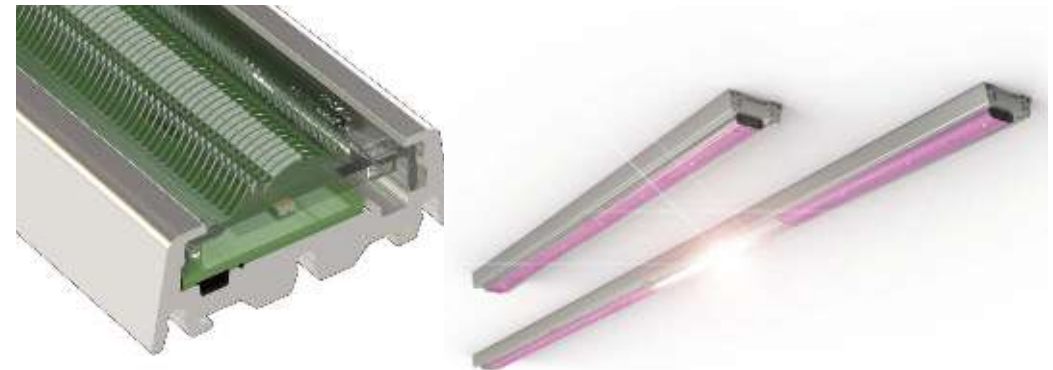

APPLICATION EXAMPLES

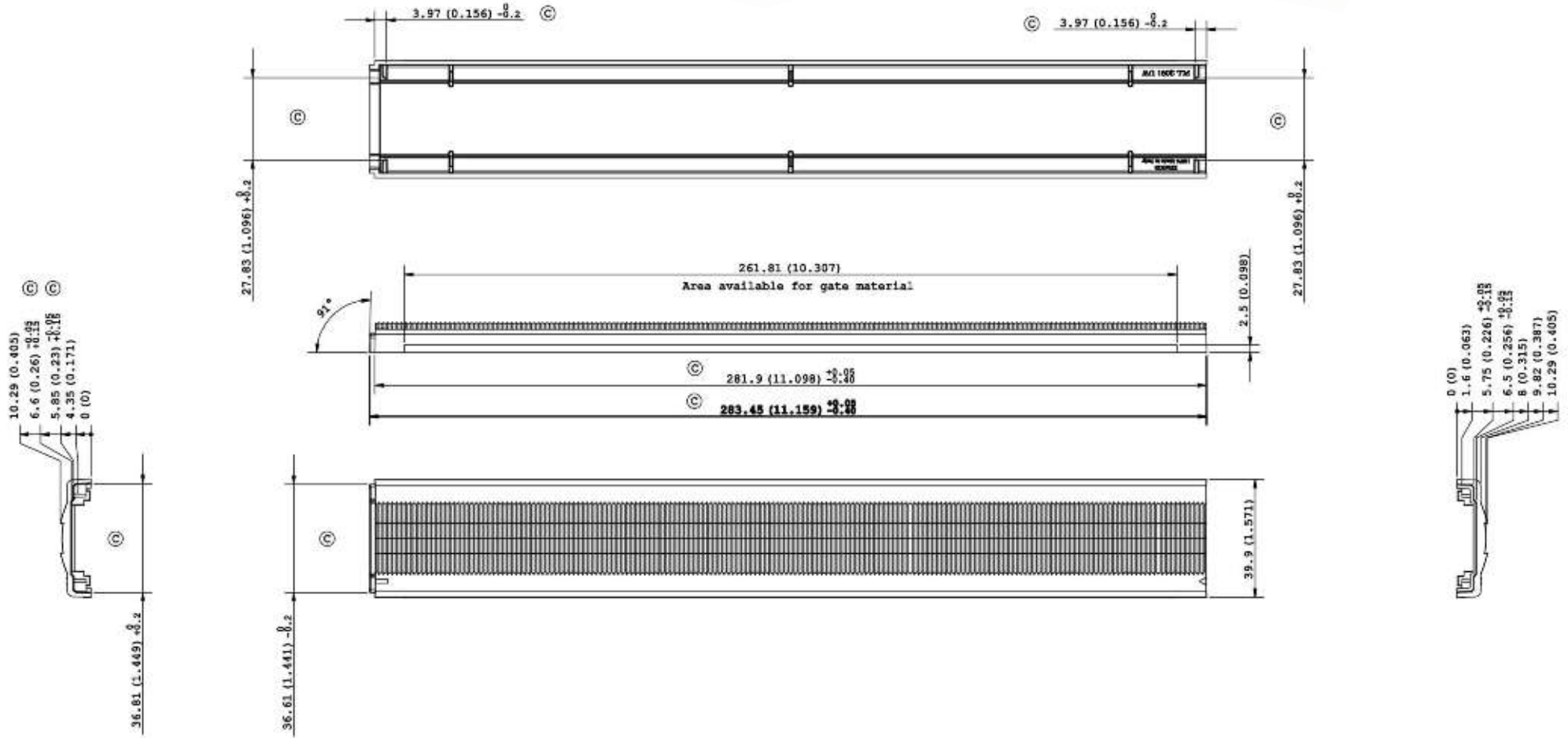
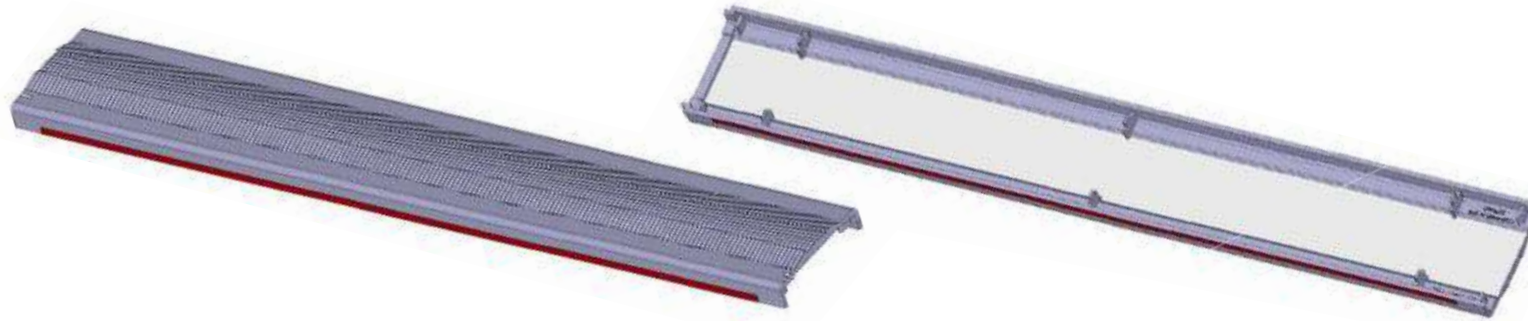

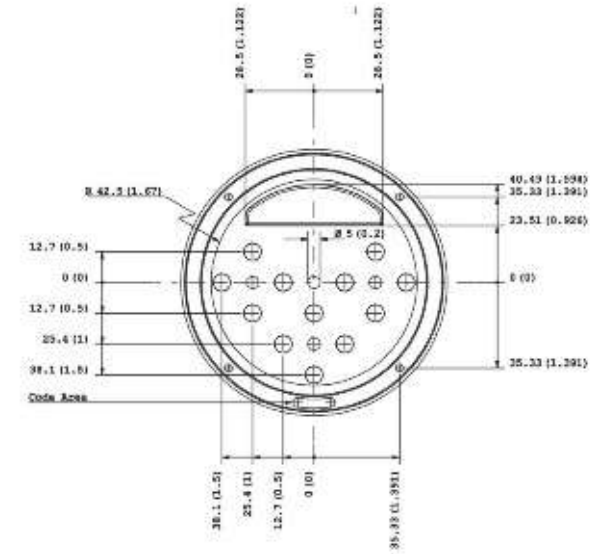
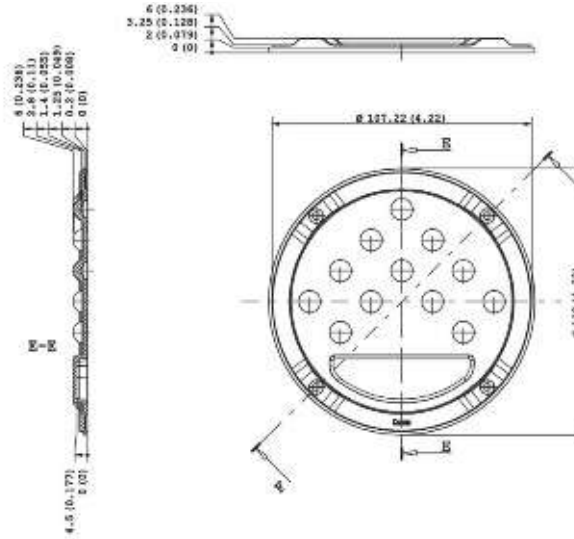
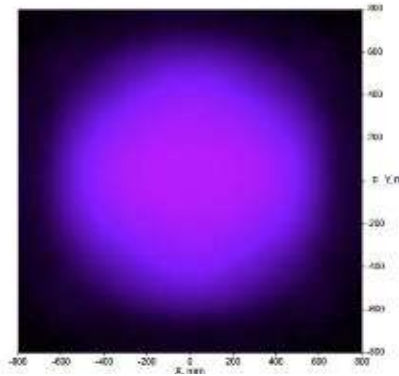

KMF1260AUV

Material: **PMMA UV** for the Optic, Silicone for the Gasket
Full angle C0-C180 at 50% from maximum: ~ 60°

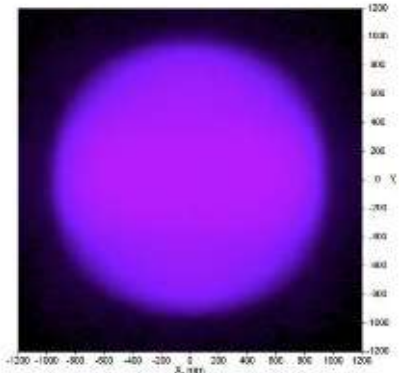

APPLICATION EXAMPLES

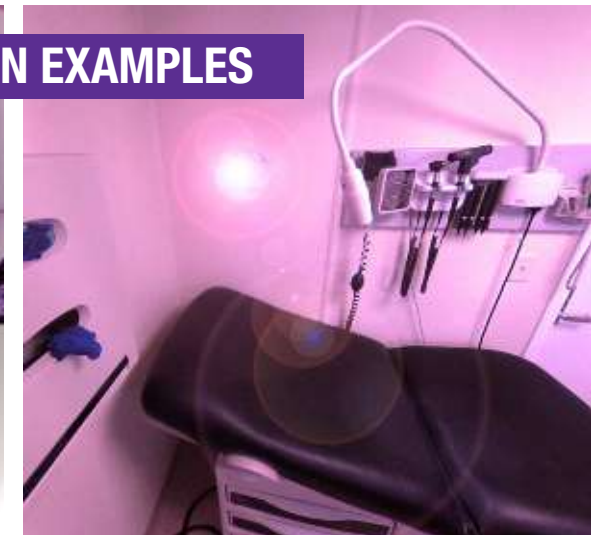

KMF1290AUV

Material: **PMMA UV** for the Optic, Silicone for the Gasket
Full angle C0-C180 at 50% from maximum: ~ 90°



PLL2102UWUV

Material: **PMMA UV** for the Optic, Silicone for the Gasket
Full angle C0-C180 at 50% from maximum: ~ 117°x140°

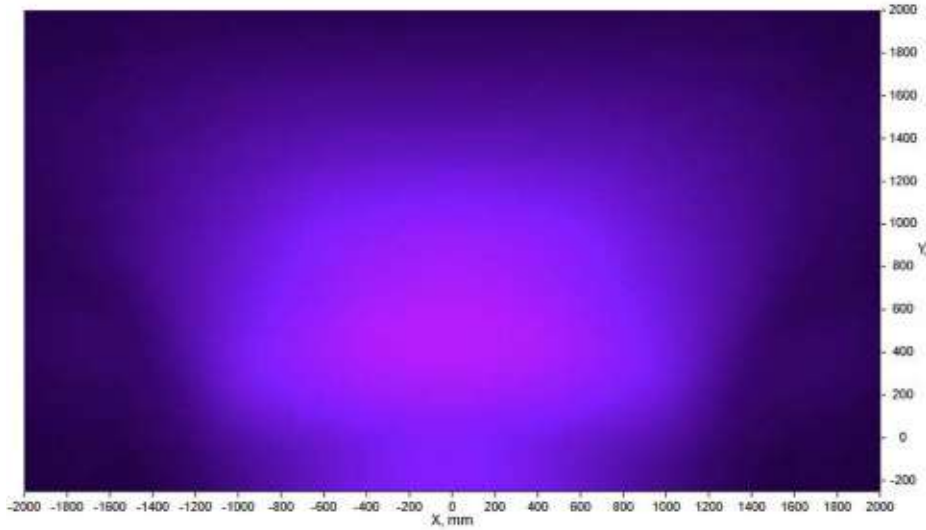
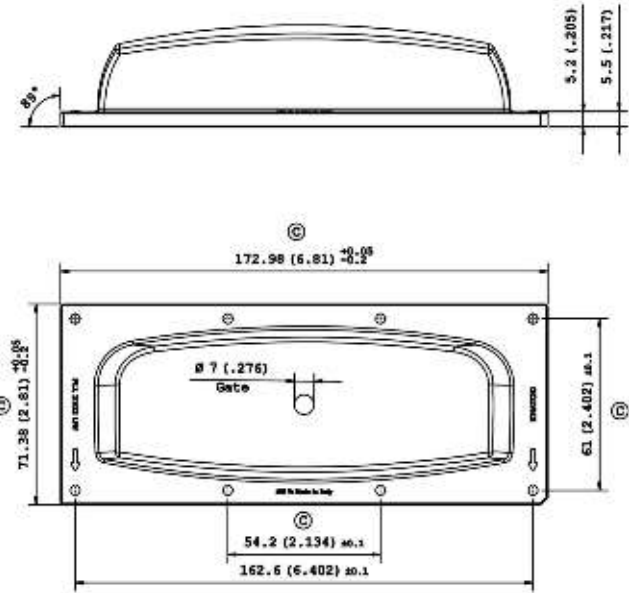
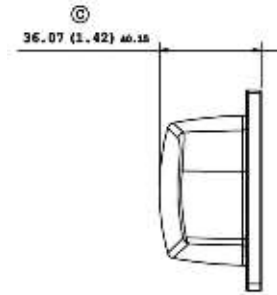
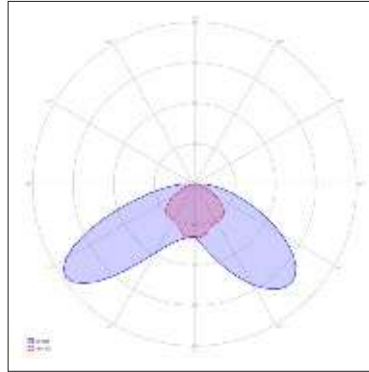

APPLICATION EXAMPLES

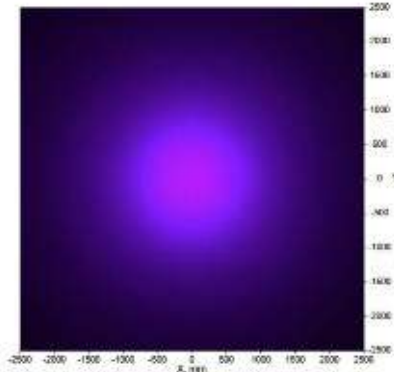

PLL2056SR77

Material: **SILICONE** for the Optic, PC or Aluminium for the Holder
Full angle C0-C180 at 50% from maximum: ~ 60°

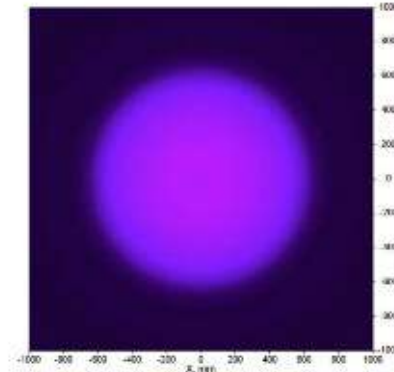

PLL2056SR99

Material: **SILICONE** for the Optic, PC or Aluminium for the Holder
Full angle C0-C180 at 50% from maximum: ~ 45°

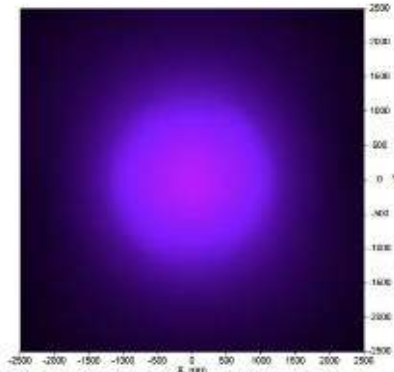

PLL2056SR88

Material: **SILICONE** for the Optic, PC or Aluminium for the Holder
Full angle C0-C180 at 50% from maximum: ~ 90°

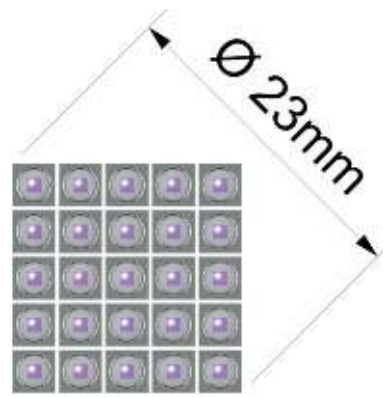

EXAMPLE OF LED CLUSTER

This optic series can be used with a cluster of single LEDs creating an emitting area up to 23mm.

SIO3 JUNIOR

OPTICS MADE OF OPTICAL GRADE SILICONE FOR CLUSTERED UVC LED @ 280nm
WORKING RANGE: 250nm - 450nm



DISINFECTION LIGHT

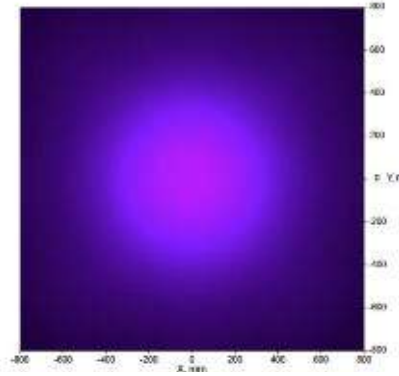

PLL2087NASR

Material: **SILICONE** for the Optic, PC or Aluminium for the Holder
Full angle C0-C180 at 50% from maximum: ~ 25°

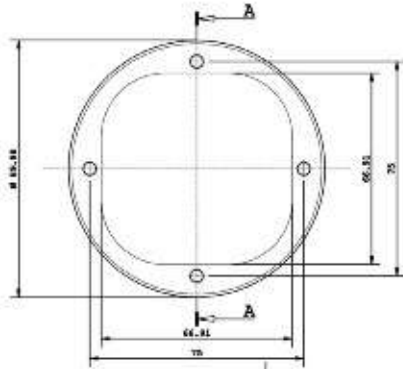
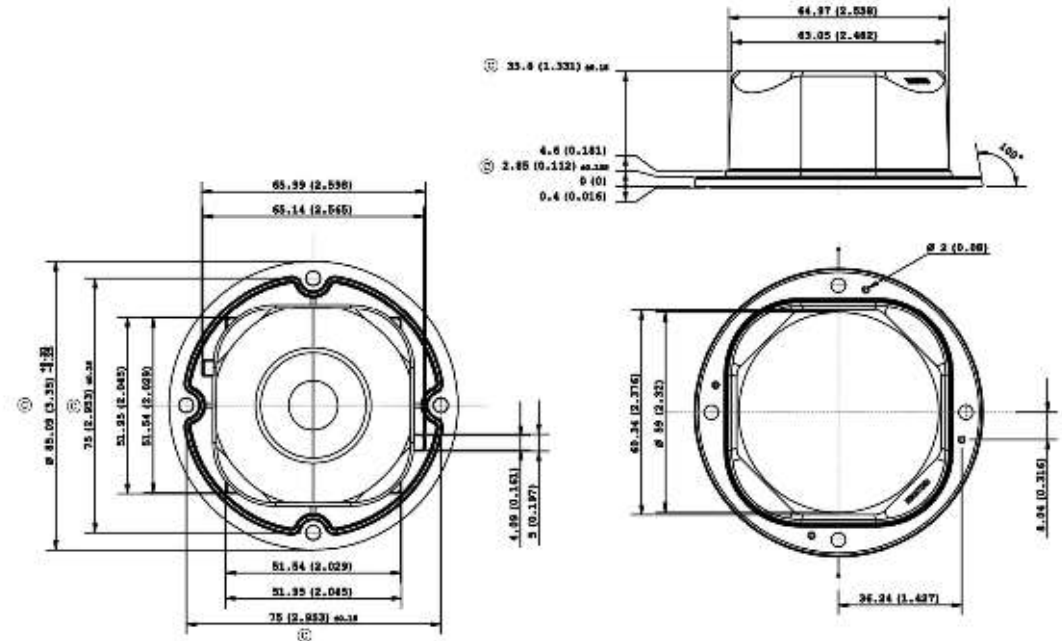

KEL2056ALU Fixing Ring

Material: **ALUMINIUM**

KEL2056 Drawing



APPLICATION EXAMPLES

ADVANCED TECHNOLOGY UNIQUE PROJECTS READY-TO-USE

Khatod optics enable to realize your most demanding applications in LED Lighting.

Pioneer of SILICONE LENSES, unique to OPTICAL SYSTEMS, forerunner of new-concept REFLECTORS, skilled developer of CUSTOM OPTICS. To its customers, Khatod makes available its newest industrial area – 30,000sqm of advanced technology - free of charge technical support, fast deliveries from HQ, corporate sales offices around the world and global distributors of the industry.

Standard products: over 7900 models from stock – optics, optical systems and reflectors – for most popular LEDs, for any kind of applications in LED Lighting. Made from top quality materials – optical grade PMMA for HT, PC HT, ULTRA-CLEAR SILICONE (LSR) – by using exclusive manufacturing processes and superior finishing.

Custom Optics: Khatod started as manufacturer of custom optics when LED Lighting was in its early days. Since then, our lenses have been developing alongside the newest LEDs. Who can offer better expertise than Khatod? The answer is easy: nobody. Unique on the international scene, Khatod develops the entire product process 100% in-house, Milano-Italy. No outsourcing. For your new projects, do not hesitate to contact Khatod. You will find not only a manufacturer of optics, but a real partner in your project.

Since 1985, from Project to Object. 100% Made in Khatod, Italy.



KHATOD

1 0 0 % M A D E I N I T A L Y

We Manufacture Solutions

HEAD QUARTER

Via Alessandrina 25, Cusano Milanino, (Milan) Italy - Phone +39 02 66013695 - Fax +39 02 66013500 - khatod@khatod.com - www.khatod.com

USA

khatodusa@khatod.com

INDIA

khatodindia@khatod.com

TURKEY

khatodturkey@khatod.com